

EPON OLT Products User Manual

**FD1104S/FD1104SN/FD1104B/FD1104Y/
FD1108S**

---Quick Configuration Guide

Version: V1.3

©Statement

Copyright ©2019 Shenzhen C-Data Technology Co., Ltd. All Rights Reserved. No part of this manual may be reproduced or transmitted in any form or by any means without the prior written consent.

The information in this document may be update at any time due to productversions upgrade or any other reasons. Unless otherwise agreed, this manual is for reference only. All statements, information and recommendations in this manual do not constitute the warranty of any kind, express or implied.

Please contact your suppliers to get the latest version of this document,thank you !

About This Manual

This manual is applicable to C-Data company FD1104B、FD1104S、FD1104SN、FD1104Y、FD1108S EPON OLT products quickly installation configuration guide, Is the user to quickly and easily manage EPON OLT equipment should read the information before guidelines.

The related documents for EPON OLT device are:

《FD1104S/FD1104B/FD1104SN/FD1104Y/FD1108S EPON OLT User Manual-D
evice Installation Guide》

《FD1104S/FD1104B/FD1104SN/FD1104Y/FD1108S EPON OLT User Manual-C
LI Operation Guide》

《FD1104S/FD1104B/FD1104SN/FD1104Y/FD1108S EPON OLT User Manual-E
MS Software Part》

Content

1 Read Instruction	1
Document Scope	1
Revision History	1
Proper Noun	1
Note.....	2
2 OLT Login Manage.....	2
2.1 OLT Login Manage Explanation	2
2.2 OLT Login By Console	2
2.3 OLT Login By Telnet	3
3 OLT Upgrade Method.....	4
4 OLT WEB Access Management Installation Method	7
5 OLT Service Configuration ---CLI Command Method.....	9
5.1 FTTH Service Topology.....	9
5.2 Data Plan	10
5.3 Configuration Guide	10
5.4 Configure OLT Service	11
5.4.1 Enable switch based on vlan	11
5.4.2 Configure OLT Global Vlan.....	11
5.4.3 Configure OLT GE Port Service Vlan	11
5.4.4 Configure OLT PON Port Service Vlan.....	14
5.4.5 Configure OLT Multicast Service.....	14
5.5 Check ONU Register Status.	15
5.6 Configure Bridge ONU(SFU) Service.....	15
5.6.1 Configure Bridge Onu(SFU) Internet Service.....	15
5.6.2 Configure Bridge Onu(SFU) Multicast Service.....	19
5.7 Configure Gateway ONU (HGU) Service	19
5.7.1 Configure Gateway ONU (HGU) Internet Service--RTK Solution ONU.....	19
5.7.2 Configure Gateway ONU (HGU) Multicast Service--RTK Solution ONU.....	21
5.7.3 Configure Gateway ONU (HGU) Internet Service--ZTE Solution ONU	22
5.7.4 Configure Gateway ONU (HGU) Multicast Service--ZTE Solution ONU	23
5.7.5 Configure Gateway ONU (HGU) VOIP Service--ZTE Solution ONU	26
6 Configure OLT QinQ Service	29
6.1 Data Plan	29
6.2 Configure Processes	29
6.3 Configure OLT	29
7 Common Command Description	30
8 OLT Service Configuration ---EMS Method	30
8.1 Data Plan	30
8.2 Configuration Guide	31
8.3 Configure OLT Service.....	31
8.3.1 Configure OLT Global Vlan.....	31
8.3.2 Configure OLT GE Port Service Vlan	32

8.3.3 Configure OLT PON Port Service Vlan.....	34
8.4 Configure Bridge ONU(SFU) Service.....	35
8.4.1 Configure Bridge Onu(SFU) Internet Service.....	35
8.4.2 Configure Bridge Onu(SFU) Multicast Service.....	36
9 Configure Service In OLT ---WEB Method.....	38
9.1 Data Plan	39
9.2 Configuration Guide	39
9.3 Configure OLT Service.....	39
9.3.1 Configure OLT Global Vlan.....	39
9.3.2 Configure OLT GE Port Service Vlan	41
9.3.3 Configure OLT PON Port Service Vlan.....	44
9.4 Configure Bridge ONU(SFU) Service.....	45
9.4.1 Configure Bridge Onu(SFU) Internet Service.....	45
9.4.2 Configure Bridge Onu(SFU) Multicast Service.....	46
Concluding Remarks.....	48

1 Read Instruction

Document Scope

Reading Object	Product	Products Software Version	
C-Data company Employees, FTTX Operation&Maintenance Engineer, Customer's Technical Engineer	C-Data EPON OLT (FD1104S/FD1104B/FD1104SN/ FD1104Y/FD1108S)	V2.X.X	
Compiling Department	Technical Center Technical Support Department	Document Version	V1.3

Revision History

Date	Version	Description	Author
2016-02-28	V1.1	OLT version switch to V2.2.X, cli command line have been changed.,update config guide fully	Technical Support Department
2017-05-04	V1.2	OLT version switch to V2.4.X, cli command line have been changed.,update config guide fully	Technical Support Department
2019-03-29	V1.3	1. Add how to access the OLT web management 2. Add trunk, hybrid port mode 3. Add configure OLT QinQ service 4. Add OLT EMS and WEB management type config guide	Technical Support Department

Proper Noun

Acronym	Full name	Instructions
EPON	Ethernet Passive Optical Network	Ethernet Passive Optical Network
OLT	Optical Line Terminal	Optical Line Terminal
ONU	Optical Network Unit	Optical Network Unit
OMCI	ONU Management and Control Interface	GPON OLT&ONU Management and Control Interface(protocol)

OAM	Operation Administration and Maintenance	EPON OLT&ONU Operation Administration and Maintenance Protocol
DBA	Dynamic Bandwidth Allocation	Dynamic Bandwidth Allocation
VLAN	Virtual Local Area Network	Virtual Local Area Network
VoIP	Voice over IP	Voice over IP
WLAN	Wireless Local Area Networks	Wireless Local Area Networks
FTTH	Fiber To The Home	Fiber To The Home
FTTB	Fiber To The Building	Fiber To The Building

Note

- The command line described in the document is case sensitive in OLT.
- If we meet a command that cannot be inputted or is prompted for error, we can input “?” to see the latter command format.
- Input incomplete commands can be completed by pressing the “**Tab**” key.

2 OLT Login Manage

2.1 OLT Login Manage Explanation

FD1104S、FD1104B、FD1104SN、FD1104Y、FD1108S EPON OLT support CLI,EMS and WEB management;CLI manage type divided into telnet remote manage and console local manage, please check #2.2 and #2.3 chapter to see concrete operations;please check EMS user manual to see EMS manage way;please check #4 to see WEB manage way.

2.2 OLT Login By Console

First,find console port on OLT front surface (which is a RJ45 port have been mark “**CONSOLE**”) .if want to login OLT by Console port,we need do prepare as follows:

- Need RJ-45-to-DB-9 serial line
- Connect PC to OLT console port,find COM number in “**computer management**”
- Software for logging OLT by console port(Putty,SecureCRT)
- parameter for console login software

Baud Rate:9600

Parity Check:None

Databit:8

Stopbit:1

Flow Control:None

Login OLT by console login software,then input **username:admin,password:admin**

【OLT Console Connection Diagram】

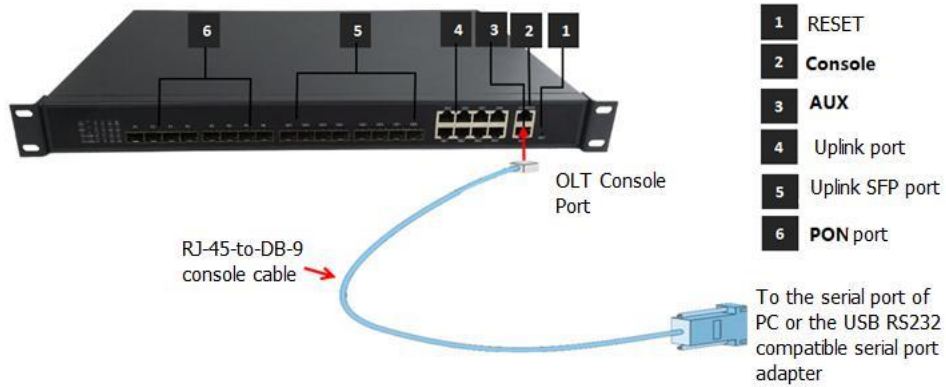

【OLT Console Connection Device】



RJ-45 to DB-9 Console Cable

USB to RS-232 compatible serial port adapter

Port on Computer	Required Cable	Port on OLT
Serial Port	RJ-45 to DB-9 Console Cable	RJ-45 Console Port
USB Type-A Port	<ul style="list-style-type: none"> ● USB to RS-232 compatible serial port adapter (Adapter may require a software driver) ● RJ-45 to DB-9 Console Cable 	

2.3 OLT Login By Telnet

There are two way to telnet,one is outband management,another is inband management.:

#1: Outband management(connect OLT MGMT port)

Set PC ip as 192.168.1.X(except **192.168.1.100**),PC connect to OLT MGMT port, login the OLT with OLT default manage IP (default IP : **192.168.1.100**). then input username and

password,default login username and password is:**admin/admin**

Use command as follow can modify the outband management IP:

```
epon# system ipconfig outband 192.168.5.88 255.255.255.0
```

#2: Inband management(connect OLT ge port)

First we login olt via console port or mgmt port, and configure a management-vlan,add the ge port to the vlan(ge port vlan mode can be access or trunk,which depends on your network environment), then configure the inband-ip, pc connect to OLT ge port (ge1-ge8) and telnet to the OLT.

(Example)The way to set inband mangement ip as follows:

```
epon# vlan 50
epon# system ipconfig mgmt-vlan 50
epon# swport ge7
epon(GE-7)# vlan add 50
epon(GE-7)# pvid 50
epon(GE-7)# exit
epon# system ipconfig inband 192.168.6.100 255.255.255.0
```

3 OLT Upgrade Method

Attention Before Upgrade:

The new version(OLT V2.3.X) is different from the olt version(before OLT V2.3.X). There are two management IP in the new version, such as in-band management IP and out-of-band management IP. But There is only one management IP in the old version.

So we adjust something about the in-band and out-of-band management IP. As follows:

1. Before the OLT is default ip address 192.168.1.100,after upgrade to V2.3.1 version:

OLT uplink port manage ip address is:192.168.8.100

OLT AUX/MGMT port manage ip address is:192.168.1.100

2. Before the OLT manage ip address have been change to 192.168.1.X not is 192.168.1.100 ,after upgrade to V2.3.1 version:

OLT uplink port manage ip address is:192.168.1.X

OLT AUX/MGMT port manage ip address is:192.168.2.100

3. Before the OLT manage ip address have been change to other not is 192.168.1.X ,after upgrade to V2.3.1 version:

OLT uplink port manage ip address is:It is before you are changed ip address.

OLT AUX/MGMT port manage ip address is:192.168.1.100

Upgrade Process Guidance:

1. Set up OLT update topology:

Use a PC as FTP server(run wftpd32.exe or Wftpd.exe in this pc),and connect to OLT mgmt port or ge port to transmit firmware.

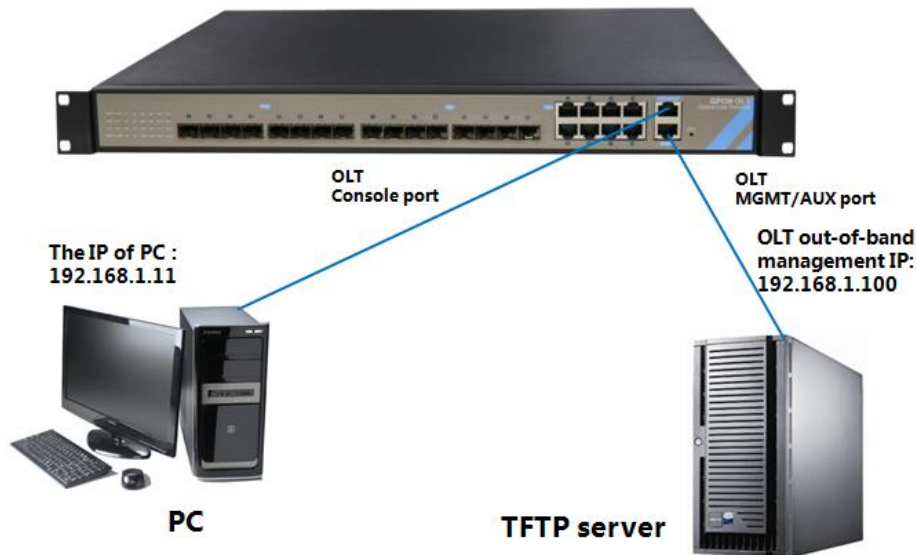

Note: This tutorial will take the PC as a server, and the IP of PC is 192.168.1.11, management IP of the OLT is 192.168.1.100.

2. Test network connectivity

- a. Connect PC to OLT console port, used for updating OLT in boot mode.
- b. Connect pc to OLT MGMT port or ge port, configure PC ip and OLT ip (inband ip or outband ip) are in same segment.
- c. PC can ping OLT management IP, if pc can ping OLT management ip, means OLT can connect to TFTP server.
- d. **Close PC firewall, prevent firewall intercept FTP software.**

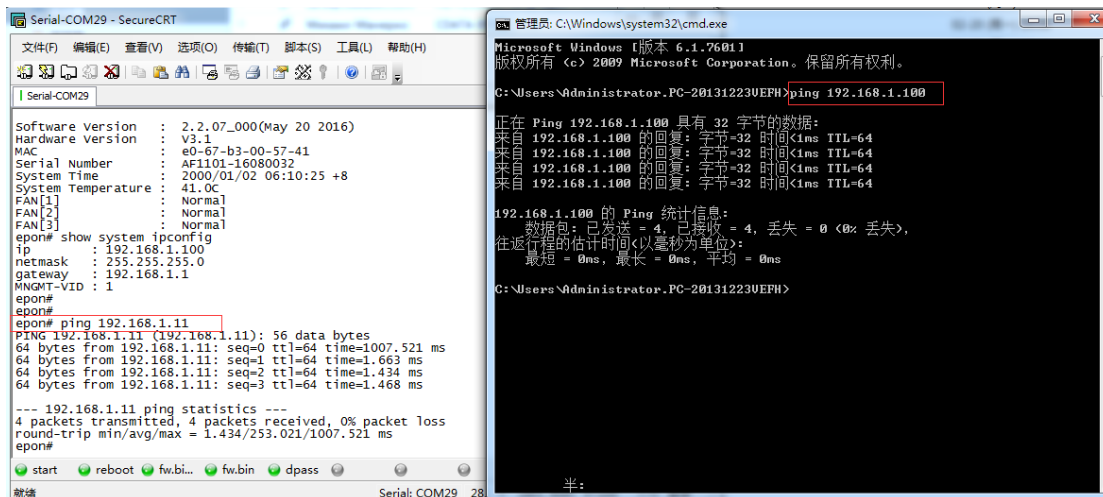

3. TFTP server configuration

- (1)Open the TFTP software;
- (2)Specifies the path to the firmware to be upgraded;
- (3)Specifies the IP address of the server (ie PC);

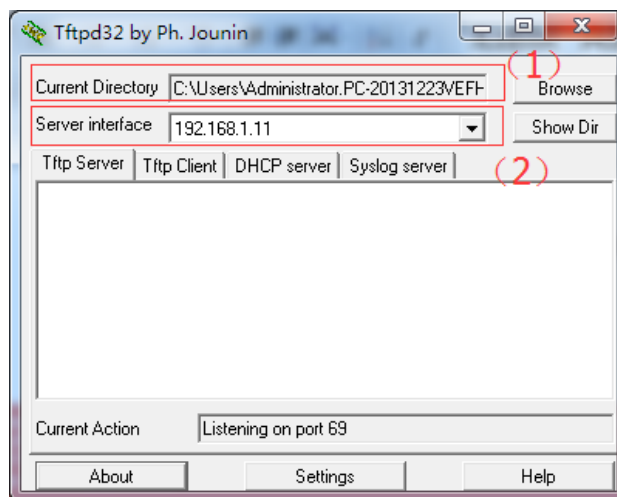

4. OLT update command

OLT the common upgrade method please see below:

a. Input command as follows to update OLT

epon# system update firmware FD1108S_V2.4.05_180517_X000.img tftp-server 192.168.1.11

Transferring the Image file, please wait...

Upgrading begins, please wait and notice the rate of progress

Any operation such as reboot or switchover will cause failure and unpredictable result

The upgrading starts

The percentage of erasing flash is: 01%

The percentage of erasing flash is: 40%

The percentage of erasing flash is: 100%

The percentage of writing flash is: 01%

The percentage of writing flash is: 38%

The percentage of writing flash is: 100%

The upgrade is successful, you must reboot system to make file take effect

b. After update OLT,we need reboot OLT(Note:only reboot OLT,OLT can use new version)

epon# system reboot

Reboot the system now<y/n>?y

4 OLT WEB Access Management Installation Method

1.First, update the WEB firmware via the #3 OLT upgrade way,(firmware name include Web word ,such as FD1108S_Web_V1.2.0_X000_180517_1326.img)

epon# system update web-server FD1108S_Web_V1.2.0_X000_180517_1326.img tftp-server 192.168.1.11

Transferring the Web Server file, please wait...

Upgrading Web Server ...

Restarting Web Server ...

OK!

2.PC connect to OLT mgmt port or inband management port,make sure PC can ping OLT inband management ip or outband management ip

3.Before accessing OLT's web management from a PC, you need to enable OLT's SNMP and web access functionality by the OLT command line.The configuration command is as follows:

epon# system web enable

epon# system web default-port

epon# system snmp community read-only public

epon# system snmp community read-write private

4.After the OLT WEB firmware upgrade,can use below method check the OLT if have the web firmware version informaton,if see the information on the OLT,this mean the OLT have the web firmware version:

```
epon# show system infor
-----
System Description : 123
Software Version   : 2.4.05_000(May 17 2018)
Hardware Version   : 3.00
MAC                : e0-67-b3-00-57-41
Serial Number      : AF1101-16080032
System Time        : 2019/03/21 14:41:12 +08:00
Location           : shenzhen
Contact            : 109
-----
Web Server
Version            : V1.2.0
BuildTime         : 18-05-17 13:26:25
Administrator     : admin
Password          : admin
-----
System Temperature : 48.5C
FAN[1]            : Normal
FAN[2]            : Normal
FAN[3]            : Normal
-----
epon#
```

5. Open PC browser input OLT management ip (recommend using Firefox web browser), then we can see web login interface, web login username and password is: **admin/admin**

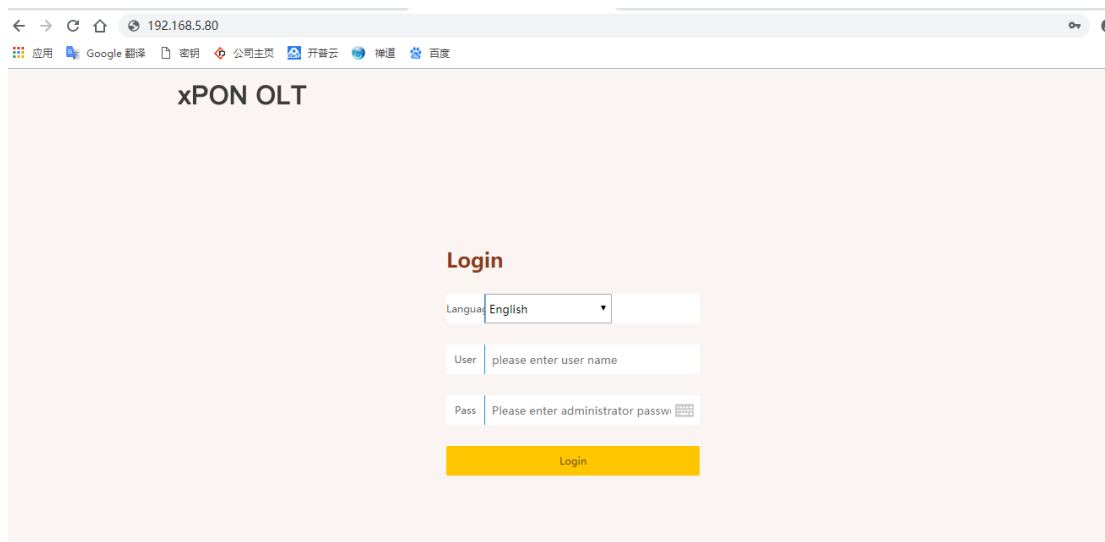

6. Customized web management information configure. PC access to OLT web via <http://X.X.X.X/cgi/customer.php> And enter parameter. Click "OK". Restart the OLT web in browser then can view the customized informations.

Language: Support Chinese and English. The default is Chinese.

Customer: Customer ID. Provided by C-Data. The default is neutral.

SecretKey : Customer ID secretkey. Provided by C-Data. The default is neutral.

Version : Customized web management system version.

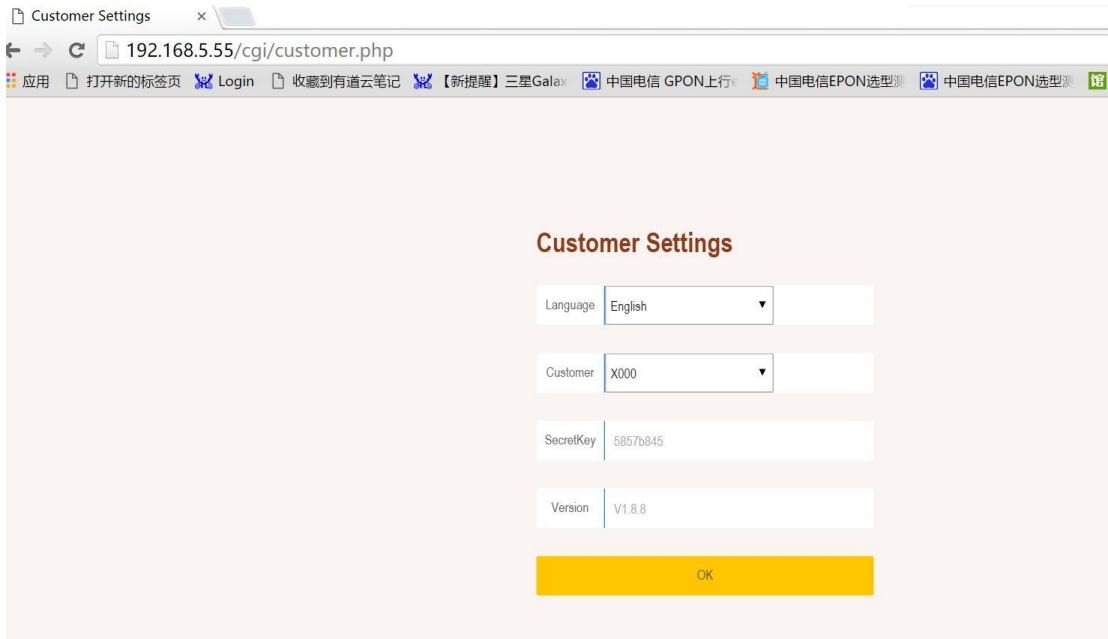

Customer Settings

Language English

Customer X000

SecretKey 5857b845

Version V1.8.8

OK

7. Other instructions

a. Web management system's username and password is independent, default is admin/admin. This username and password can modify in web interface and would not affect other access mode.

b. Web management system need to work in V2.4.02 OLT basic firmware. In old OLT basic version can't not support the web function. So if you need to use web function. Please upgrade OLT basic firmware to V2.4.02 or newer at first.

5 OLT Service Configuration ---CLI Command Method

This section mainly introduce 4Port/8Port OLT internet service, voice service and multicast service in FTTH environment. Mainly introduce the bridge ONU(SFU) and Home Gateway ONU (HGU), The following will introduce the service configuration way for OLT and ONU according to two types ONU.

5.1 FTTH Service Topology

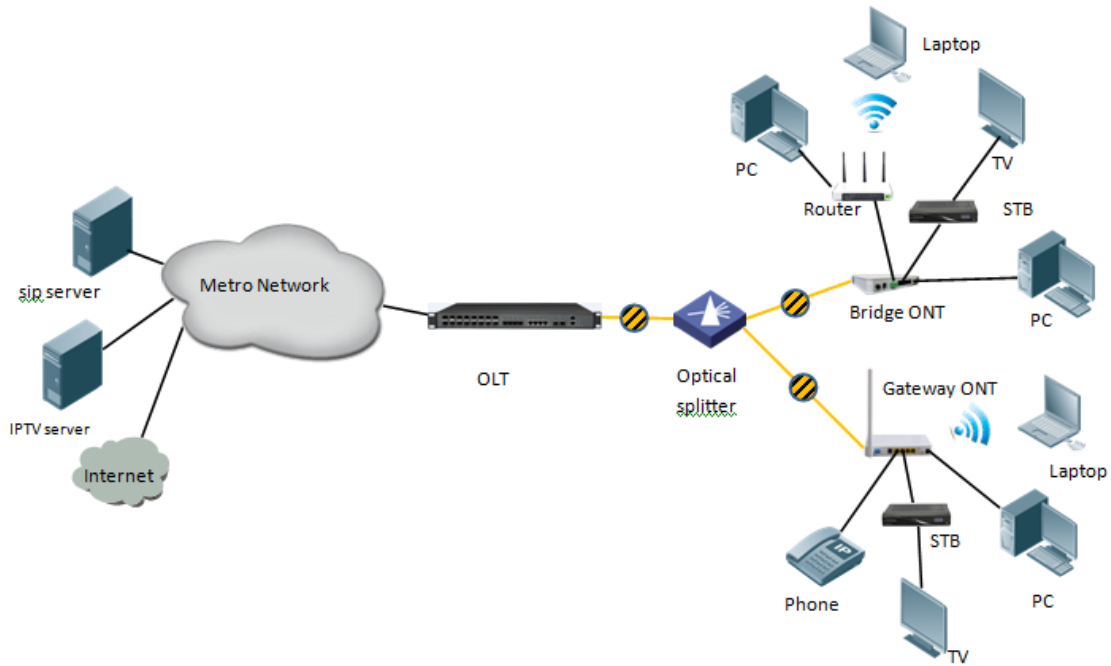

5.2 Data Plan

Main Data Plan List	
Configuration Item	Data
VLAN Data	VLAN 100: Internet Service VLAN 200: IPTV Service VLAN 300: VOIP Service
OLT Port Setting	Ge1: VLAN 100 access mode Ge2: VLAN 200 access mode Ge3: VLAN 300 access mode PON1: VLAN 100, VLAN 200, VLAN 300 trunk mode
ONU Register ID	Bridge ONU ID: 1 Gateway ONU ID: 2
Bridge ONU Port config	LAN 1: VLAN 100 LAN 2: VLAN 200 LAN3: VLAN 300 ---connect to VOIP phone
Gateway ONU Port config	Internet WAN: VLAN 100 IGMP WAN: VLAN 200 VOICE WAN: VLAN 300

5.3 Configuration Guide

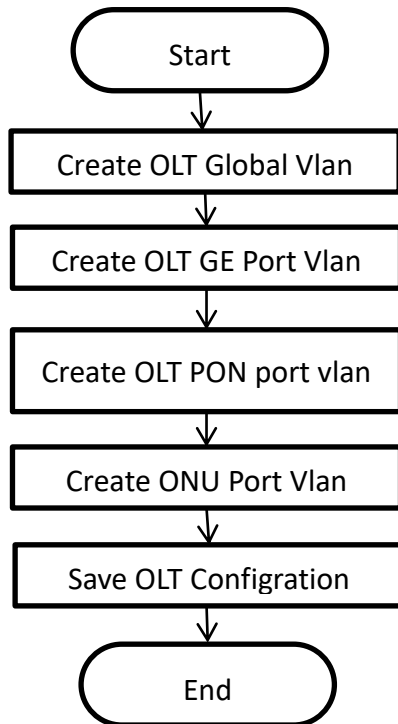

5.4 Configure OLT Service

5.4.1 Enable switch based on vlan

```
epon#swmode vlan enable //If on the OLT need support the vlan,this function is must enable
```

5.4.2 Configure OLT Global Vlan

We can use **epon# show vlan all** to show the created vlan.

If the created vlan can't meet the need,we can according below mehtod created new vlan on the OLT,According to the data plan, we create vlan100,vlan200,vlan300 firstly:

5.4.3 Configure OLT GE Port Service Vlan

We can config GE port vlan mode as access,hybrid and trunk,we can configure different mode according to our network plan, configure way of three mode as follows.

Configure GE 1,2,3 port vlan mode is access(in this document,GE port connect to PC,so we configure ge port vlan mode as access):

 **Note:**

If the port has only one vlan untag mode and the same as the pvid, then the port is access mode. As follows:

```
epon# swport ge1 // Enter ge1 configuration view
epon(GE-1)# pvid 100 //Config PVID 100, give to ingress untag packet used
epon(GE-1)# vlan add 100 //Config vlan 100 untag,give to egress packet strip vlan tag 100
```

```
epon(GE-1)# exit
epon# swport ge2           // Enter ge2 configuration view
epon(GE-2)# pvid 200       // Config PVID 200, give to ingress untag packet used
epon(GE-2)# vlan add 200   // Config vlan 200 untag,give to egress packet strip vlan tag 100
epon(GE-2)# exit
epon# swport ge3           // Enter ge3 configuration view
epon(GE-3)# pvid 300       // Config PVID 300, give to ingress untag packet used
epon(GE-3)# vlan add 300   // Config vlan 300 untag,give to egress packet strip vlan tag 100
epon(GE-3)# exit
```

Configure GE 1,2,3 port vlan mode is trunk, default pvid is 1.(If the port is configured with multiple vlan and tag mode, the port is in trunk mode):

 **Note:**

If the port is configured with multiple vlan and tag mode, the port is in trunk mode. As follows:

```
epon# swport ge1           // Enter ge1 configuration view
epon(GE-1)# vlan add 100 tag //Take the port add to vlan 100,vlan 100 is tag mode
epon(GE-1)# exit
epon# swport ge2           // Enter ge1 configuration view
epon(GE-2)# vlan add 200 tag // Take the port add to vlan 200,vlan 200 is tag mode
epon(GE-2)# exit
epon# swport ge3           // Enter ge3 configuration view
epon(GE-3)# vlan add 300 tag // Take the port add to vlan 300,vlan 300 is tag mode
epon(GE-3)# exit
```

Configure GE 1,2,3 port vlan mode is hybrid(If the port is configured with multiple vlan and some of which are tagged and the others are untag mode, the port is in hybrid mode):

 **Note:**

If the port is configured with multiple vlan and some of which are tagged and the others are untag mode, the port is in hybrid mode. As follows:

```
epon# swport ge1           // Enter ge1 configuration view
epon(GE-1)# pvid 100       //Config PVID 100, give to ingress untag packet used
epon(GE-1)# vlan add 100   //Config vlan 100 untag,give to egress packet strip vlan tag 100
epon(GE-1)# vlan add 110   //Config vlan 110 untag,give to egress packet strip vlan tag 110
epon(GE-1)# vlan add 120 tag // Take the port add to vlan 120,vlan 120 is tag mode
epon# swport ge2
epon(GE-2)# pvid 200
epon(GE-2)# vlan add 200
epon(GE-2)# vlan add 210
epon(GE-2)# vlan add 220 tag
```



```
epon# swport ge3
epon(GE-3)# pvid 300
epon(GE-3)# vlan add 300
epon(GE-3)# vlan add 310
epon(GE-3)# vlan add 320 tag
```

 **NOTE:**

The OLT vlan every mode handle process as follows:

Vlan mode	Direction	Message have vlan tag or not	Handling method
Access mode	In	vlan tag	Discard
		untag	Add port configured vlan in access mode for message (main parameter is VID),and forward
	Out	vlan tag	Forward message to the corresponding port according to VID and remove vlan tag;if the VLAN ID of the Tagged message is not same to the port VID, it is discard.
		untag	Discard
Trunk mode	In	vlan tag	If the VLAN in the message is permit to pass port, it will be forwarded directly; If the VLAN in the message doesn't permit to pass port, it is discarded.
		untag	Add default vlan(native-vlan) for untagged message and forward.
	Out	vlan tag	If the VLAN in the message is permit to pass port, it will be forwarded directly; If the VLAN ID of the message is the default (native-VLAN)VLAN, then the VLAN tag is discard and forward;if the VLAN in the message doesn't permit to pass port, it is discarded.
		untag	Discard
Hybrid mode	In	vlan tag	If the VLAN in the message is permit to pass port, it will be forwarded directly; If the VLAN in the message doesn't permit to pass port, it is discarded.
		untag	Add default vlan(native-vlan) for untagged message and forward.

	Out	vlan tag	If the VLAN in the message is permit to pass port,according vlan tag or vlan untag of message to discard or no discard vlan tag,then forward message,If the VLAN ID of the message is the default (native-VLAN) VLAN, then the VLAN tag is discard and forward; If the VLAN in the message doesn't permit to pass port, it is discarded.
		untag	Discard

5.4.4 Configure OLT PON Port Service Vlan

We can config PON port vlan mode as access,hybrid and trunk,according to our network plan configure different mode;if message from ONU is untag,we can configure PON port vlan mode is access or hybrid untag mode;if message from ONU is tag,we can configure PON port vlan mode is trunk or hybrid tag mode; configure way as follows.

Config PON1 port vlan mode is access:

```
epon# swport ge9
epon(GE-9)# pvid 100
epon(GE-9)# vlan add 100
epon(GE-9)# exit
```

Config PON1 port vlan mode is trunk: (PON port is trunk mode in this document) :

```
epon# swport ge9
epon(GE-9)# vlan add 100,200,300 tag
epon(GE-9)# exit
```

Config PON1 port vlan mode is hybrid:

```
epon# swport ge9
epon(GE-9)# pvid 200
epon(GE-9)# vlan add 100 tag
epon(GE-9)# vlan add 200
epon(GE-9)# exit
```



Note:

In the 4 port OLT CLI , PON port 1 is GE5, and so on (PON1-PON4 is GE5-GE8) ;
In the 8 port OLT CLI , PON port 1 is GE9, and so on (PON1-PON8 is GE9-GE16) ;

5.4.5 Configure OLT Multicast Service

Accroding the data play the OLT multicast vlan is use vlan 200,the uplink port is ge2,configure IGMP and multicast-vlan 200:

```
epon# igmp mode proxy // IGMP is proxy mode
```

```

epon# multicast-vlan 200 //Create and enter multicast vlan200 view
epon(multicast-vlan-200)# igmp router-port ge2 // Configure the multicast routing port as ge2
OLT(config-multicast-vlan-200)# igmp match group ip 224.1.1.1 to-ip 224.5.5.5
// Configure multicast vlan200 to match the multicast address segment 224.1.1.1-224.5.5.5
OLT(config-multicast-vlan-200)# exit //Exit the multicast vlan 200 view
epon#btv //Enter the btv view
epon(btv)# igmp user add user-index 1 pon 1 ont 1 vlan 200
// Add btv user binding specified ONU and vlan
epon(btv)#exit //Exit the btv view
epon# multicast-vlan 200
epon(multicast-vlan-200)# igmp member user-index 1
// Add multicast users to multicast vlan200
OLT(config-multicast-vlan-200)# exit

```

5.5 Check ONU Register Status.

ONU is automatically registered by default on the OLT,use below command can check the ONU if registered and online success on the OLT :

```

epon# show olt 1 online-onu
-----
Port  ONU  MAC                Type          CTC  Dist(m)  Software-Ver
-----
1      12   00-01-62-45-99-0b  ONU4GE1P1TV  3.0  6        V1.1.3
1      13   e0-fa-07-f5-03-fd  ONU1GERW     3.0  24       V2.1.4
-----
Total: 2 online.

```

5.6 Configure Bridge ONU(SFU) Service

SFU type ONU need enter OLT to config ONU one by one,config way as follows:

5.6.1 Configure Bridge Onu(SFU) Internet Service

Premise condition of ONU to open internet service:

- OLT connect to uplink device and open internet service
- OLT have created vlan for internet service
- OLT have configured GE port vlan
- OLT have configured PON port vlan
- ONU have registered

SFU ethernet port vlan mode have transparent,tag(access),trunk mode and so on,we can according to our network plan configure different mode.All onu vlan is configured by OLT,configure way as

follows:

Configure ONU1 eth1 vlan mode is tag(access) (ONU eth port vlan mode is tag in this document):

```
epon# olt 1 //Enter the PON port
epon(olt-1)# onu 1 //Enter the ONU
epon(olt-1/onu-1)# uni 1 //Enter the uni of ONU
epon(olt-1/onu-1/uni-1)# ctc vlan-mode tag 0x8100 0 100 //Config ONU port vlan
epon(olt-1/onu-1/uni-1)#exit
```

Configure ONU1 eth1 vlan mode is transparent:

```
epon# olt 1
epon(olt-1)# onu 1
epon(olt-1/onu-1)# uni 1
epon(olt-1/onu-1/uni-1)# ctc vlan-mode ctc vlan-mode transparent
epon(olt-1/onu-1/uni-1)#exit
```

Config ONU1 eth1 vlan mode is trunk:

```
epon# olt 1
epon(olt-1)# onu 1
epon(olt-1/onu-1)# uni 1
epon(olt-1/onu-1/uni-1)# ctc vlan-mode trunk 0x8100 0 100 vlan-list 200,300
epon(olt-1/onu-1/uni-1)#exit
```

 **Note:**

The port vlan mode of ONU is as follows:

【Transparent Mode】

Direction	Type	Processing method
Upstream	Untag frame	Untag frame does not make any change, forwarding
	Tag frame	Tag frame does not make any changes (original VLAN TAG), forwarding
Downstream	Untag frame	Untag frame does not make any change, forwarding.
	Tag frame	Tag frame does not make any changes (original VLAN TAG), forwarding.
	Tag frame	Tag frame VLAN ID belongs to the port "allowed by VLAN", forwarding; Tag frame VLAN ID belongs to the port "allowed by VLAN", forwarding; If the Tag frame VLAN does not belong to the port of the "permitted by VLAN," is discarded.

Command is as follow:

```
epon(olt-1/onu-4/uni-1)# ctc vlan-mode transparent
```

【Tag Mode (access Mode)】

Direction	Type	Processing method
Upstream	Untag frame	Switch frames on port's default VLAN(VPID),forwarding.
	Tag frame	Discard the frame
Downstream	Untag frame	Discard the frame
	Tag frame	If the Downstream Tag frame VLAN ID equal to the configuration of the VID, According to VID forwarded to the appropriate UNI port, and stripping the tag; If the downstream Tag frame VLAN ID is not equal to the configuration of the VID, then the frame is discarded
	Tag frame	Tag frame VLAN ID belongs to the port "allowed by VLAN", forwarding; Tag frame VLAN ID belongs to the port "allowed by VLAN", forwarding; If the Tag frame VLAN does not belong to the port of the "permitted by VLAN," is discarded.

Command is as follow:

```
epon(olt-7/onu-1/uni-1)# ctc vlan-mode tag <tpid> <cos> <vlan>
```

【Trunk Mode】

Direction	Type	Processing method
Upstream	Untag frame	Switch frames on port's default VLAN(VPID),forwarding.
	Tag frame	Tag frame VLAN ID belongs to the port "allowed by VLAN", forwarding; Tag frame VLAN ID does not belong to the port of the "permitted by VLAN," is discarded
Downstream	Untag frame	Discard the frame
	Tag frame	Tag frame VLAN ID belongs to the port "allowed by VLAN", forwarding; Tag frame VLAN ID belongs to the port "allowed by VLAN", forwarding; If the Tag frame VLAN does not belong to the port of the "permitted by VLAN," is discarded.

Command is as follow:

```
epon(olt-7/onu-1/uni-1)# ctc vlan-mode trunk <tpid> <cos> <default-vlan> vlan-list
```

【Translation Mode】

Direction	Type	Processing method
Upstream	Untag frame	Switch frames on port's default VLAN(VPID),forwarding.
	Tag frame	Tag frame VLAN ID in the configuration of the VID conversion list, forwarding; Tag frame VLAN ID is not in the configuration of the VID conversion list, frame discarding.
Downstream	Untag frame	Discard the frame
	Tag frame	Tag frame VLAN ID corresponds to the entry in the corresponding port of the VLAN Translation list (equal to

		the input VID configuration), According to the table to convert the VID to a corresponding VID (VID output), forwarding; If the VLAN ID in the corresponding port of the VLAN Translation list without a corresponding entry, discarding; If the TAG frame with VLAN ID as the "default VLAN", after the VLAN label forwarding is stripped down;
	Tag frame	Tag frame VLAN ID belongs to the port "allowed by VLAN", forwarding; Tag frame VLAN ID belongs to the port "allowed by VLAN", forwarding; If the Tag frame VLAN does not belong to the port of the "permitted by VLAN," is discarded.

Command is as follow :

epon(olt-7/onu-1/uni-1)# **ctc vlan-mode translation <tpid> <cos> <default-vlan> translate-list**

【Aggregation Mode】

Direction	Type	Processing method
Upstream	Untag frame	Switch frames on port's default VLAN(VPID),forwarding.
	Tag frame	<p>If the VLAN ID of the packet is equal to one of the "aggregated VLANs" in the VLAN aggregation table, the VID of the packet is converted to the corresponding VLAN to be aggr. The source of the service flow is also recorded. MAC address value, and forward;</p> <p>If the VLAN ID of the packet is not equal to any one of the "aggregated VLANs" in the VLAN aggregation table of the port, it is discarded.</p> <p>Currently, only the ONU is required to convert the VID. The conversion of other fields (such as TPID, CFI, and Pri) is not required. The ONU treats the TPID and Pri fields in the VLANConfig Parameters field of the received VLAN VariableContainer, After the TPID set to the default value (TPID = 0x8100), Pri to maintain the original value</p>
Downstream	Untag frame	Discard the frame
	Tag frame	<p>If the VLAN ID of the packet is equal to "VLAN to be aggr." In the VLAN aggregation table of the port, the VID is converted to the corresponding "aggregated VLAN" according to the MAC address value and forwarded.</p> <p>If the VID of the original tag is the default VID, the tag is forwarded and forwarded. If the VLAN ID is not equal to "VLAN to be aggr." Or the default VLAN ID is not equal, the ONU is only required VID conversion, other fields (such as TPID, CFI and Pri) conversion is not required. The ONU treats the TPID and Pri fields in the VLANConfig Parameters parameter field in the received VLAN</p>

		VariableContainer and sets the TPID of the converted VLAN tag to the default value (TPID = 0x8100). Pri remains the original value.
--	--	---

Command is as follow:

```
epon(olt-7/onu-1/uni-1)# ctc vlan-mode aggregation <tpid> <cos> <default-vlan>  
aggregation-list
```

5.6.2 Configure Bridge Onu(SFU) Multicast Service

Premise Condition

- OLT connect to uplink device and open service
- OLT have created vlan for multicast service
- OLT have configured GE port vlan
- OLT have configured PON port vlan
- ONU have registered

We need enter OLT to config ONU multicast service,configure way as follows:

Configure ONU1 multicast vlan mode is snooping,ONU1 eth2 vlan is 200,and multicast vlan mode is untag:

```
epon# olt 1  
epon(olt-1)# onu 1  
epon(olt-1/onu-1)# ctc igmp mode igmp-mld-snooping //Config ONU igmp mode to snooping  
epon(olt-1/onu-1)# ctc igmp fast-leave enable  
epon(olt-1/onu-1)# uni 2  
epon(olt-1/onu-1/uni-2)# ctc igmp vlan add 200 //Config ONU multicast vlan to 200  
epon(olt-1/onu-1/uni-2)# ctc igmp tag-handle strip-vlan-tag  
//Config ONU multicast vlan handle mode to strip,used for IPTV box
```

5.7 Configure Gateway ONU (HGU) Service

Gateway ONU (HGU) can provide internet,VOIP,IPTV service for FTTH,support PPPOE/DHCP dial-up,NAT, IGMP.Because HGU have route function, ONU service need to be configured with the local web or tr069,include wan and vlan configuration,don't need configure vlan in olt,only make sure ONU can register to OLT.OLT don't support configure ONU route wan,specific configure as follows:

5.7.1 Configure Gateway ONU (HGU) Internet Service--RTK Solution ONU

premise condition

- OLT connect to uplink device and open service
- OLT have created vlan for internet
- OLT have configured GE port vlan
- OLT have configured PON port vlan
- ONU have registered

1. Create route wan and bind LAN1 in onu web

Click Internet→Internet Config→WAN Config

Status	Internet	Security	Application
Internet Config	Port Binding	DHCP Server	WLAN Config
	Remote Mgmt	QoS	

WAN Config

WAN Connection name:

Mode:

Connection Mode:

DHCP Obtain an IP address automatically

Static Use Static IP address

PPPoE PPP over Ethernet (PPPoE)

NAT:

Enable Vlan:

Vlan ID:

802.1p:

MTU:

Request DNS: Enable
 Disable

Primary DNS:

Secondary DNS:

Service Mode:

Bind port:

Port_1 Port_2

Port_3 Port_4

wireless (SSID)

NOTE:

Mode select **Route**. Check **Enable VLAN** and Vlan ID input 100. Service Mode select **INTERNET**. Bind port check **Port_1** and **wireless(SSID)**.

Internet service take DHCP mode as an example in this document. The service type please select suitable type according to the user's actual environment. ONT detail usage please refer to ONT user manual.

2. Check ONU internet wan status

Click Status→Internet Info

Status	Internet	Security	Application	Management	Diagnosis
Device Info Internet Info LAN & WLAN TR-069 Status					
WAN Info					
Interface	VLAN ID	Protocol	IGMP	Status	IP address
1_TR069_R_VID_46	46	IPoE	Enable	down	
2_INTERNET_R_VID_100	100	IPoE	Enable	up	192.168.5.129
Network Information					
Default Gateway	192.168.5.254				
Subnet Mask	255.255.255.0				
Primary DNS	192.168.5.254				
Secondary DNS					

5.7.2 Configure Gateway ONU (HGU) Multicast Service--RTK Solution ONU

premise condition

- OLT connect to uplink device and open multicast service
- OLT have created vlan for multicast
- OLT have configured GE port multicast vlan
- OLT have configured PON port multicast vlan
- ONU have registered

1. Create bridge wan and bind LAN2 in onu web

Click Internet→Internet Config→ WAN Config

Status	Internet	Security	Application	Management	Diagnosis
Internet Config Port Binding DHCP Server WLAN Config Remote Mgmt QoS Time Config Routing					
WAN Config					
WAN Connection name	Add WAN connection ▼				
Mode :	Bridge ▼				
Connection Mode::	Ipv4/Ipv6 ▼				
Enable Vlan:	<input checked="" type="checkbox"/>				
Vlan ID:	200				
802.ip:	(NULL) ▼				
Service Mode:	Other ▼				
Bind port:	<input type="checkbox"/> Port_1 <input checked="" type="checkbox"/> Port_2 <input type="checkbox"/> Port_3 <input type="checkbox"/> Port_4 <input type="checkbox"/> wireless (SSID)				
<small>NOTE: Can not bind the same port to different WAN connection. If the same port has been binded to different WAN connection, the last configuration will flush your previous configurations on this port.</small> <small>When the Bridge mode is set to Other, the PC on the port does not dynamically obtain the IP address through the gateway. When the service mode is Other, please be careful not to bind all LAN ports for such a situation!</small>					
<input type="button" value="Apply"/> <input type="button" value="delete"/>					



NOTE:

Mode select to **Bridge**. Check **Enable Vlan**,Vlan ID input **200**. Service Mode select **Other**.Bind port click **Port_2**.

2. Config IGMP mode in ONU web

Click Application→ IGMP Config→ IGMP Snooping. Enable IGMP Snooping.

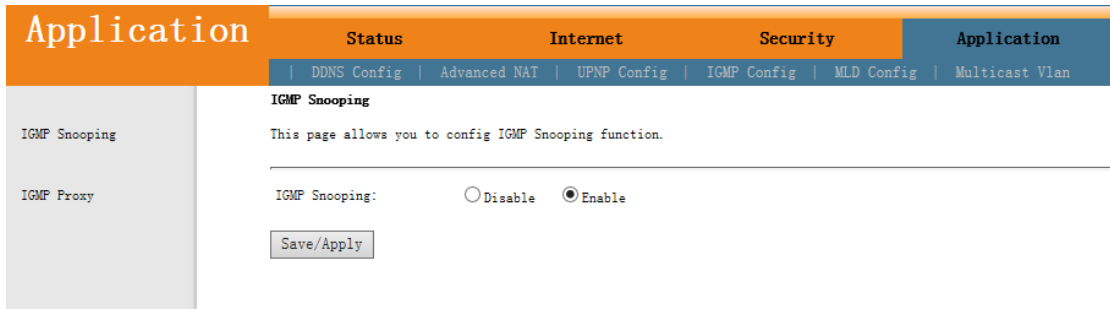

3. Configure multicast vlan on ONU web

Click Application→ Multicast Vlan→ 3_Other_B_VID_200→ Modify. Input 200 behind VLAN multicast(blank said set).

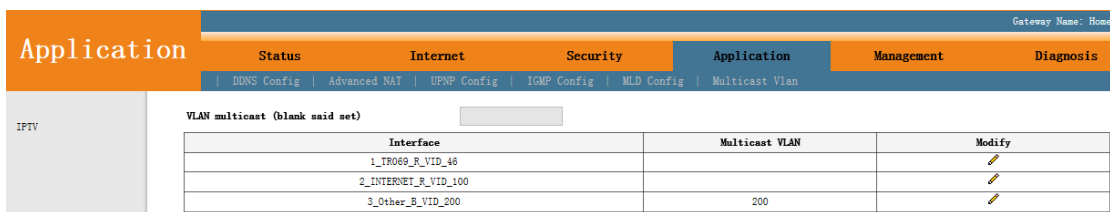

4. Check ONU multicast wan status

Click Status→Internet Info

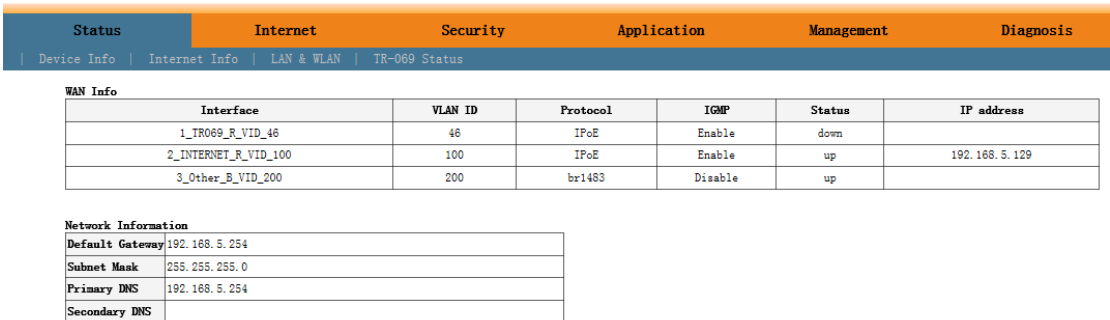

---end

5.7.3 Configure Gateway ONU (HGU) Internet Service--ZTE Solution ONU

premise condition

- OLT connect to uplink device and open internet service
- OLT have created vlan for internet
- OLT have configured GE port vlan
- OLT have configured PON port vlan
- ONU have registered

1. Create route wan and bind LAN1 in ont web

Click Network→WAN→WAN Connection. Type select to DHCP. Connection Name select to Create WAN Connection. Port Binding check LAN1 and SSID1. Service List select to INTERNET. VLAN Mode select to Used. VLAN ID enter 100. finally click Create.

1GE3FE2P1UW

Status | Network | Security | App | Administration | Diagnosis | Help

WAN

WAN Connection

4in6 Tunnel Connection

ARP Detect

DHCP Release First

Bonding configuration

LAN Configuration

PON information settings

Prefix Management

WLAN

Port Settings

TR-069

QoS

IP Version:

Type:

Connection Name:

Port Binding: LAN1 LAN2 LAN3 LAN4
 SSID1 SSID2 SSID3 SSID4

Enable DHCP:

Enable NAT:

Service List:

VLAN Mode:

VLAN ID:

802.1p:

Enable DSCP:

DSCP:

MTU:

English | Help | Logout

NOTE:

Type select to **DHCP**. Connection Name select to **Create WAN Connection**. Port Binding check **LAN1** and **SSID1**. Service List select to **INTERNET**. VLAN Mode select to **Used**. VLAN ID enter **100**. Enable DHCP and Enable NAT keep default checked status.

In this document, Internet service take DHCP mode as an example. please selected suitable service type according to the user's actual need. ONT detail use way please refer to ONT user manual.

2. Check ONT internet wan status

1GE3FE2P1UW

Status | Network | Security | App | Administration | Diagnosis | Help

Device Information

Network Interface

WAN Connection (IPv4)

WAN Connection (IPv6)

4in6 Tunnel Connection

PON Inform

PON Alarm

User Interface

VoIP Status

Remote Management Status

Type	DHCP
Connection Name	3_INTERNET_R_VID_100
NAT	Enabled
IP	192.168.5.194/255.255.255.0
DNS1	192.168.5.1
DNS2	0.0.0.0
DNS3	0.0.0.0
WAN MAC	E0:67:B3:00:00:BC
Gateway	192.168.5.1
Connection Status	Connected
Remaining Lease Time	85544sec

English | Help | Logout

---end

5.7.4 Configure Gateway ONU (HGU) Multicast Service--ZTE Solution ONU

premise condition

- OLT connect to uplink device and open multicast service
- OLT have created vlan for multicast
- OLT have configured GE port multicast vlan
- OLT have configured PON port multicast vlan
- ONU have registered

1. Create bridge wan in ont web

Click Network→WAN→WAN Connection. Type select to Bridge. Connection Name select to Create WAN Connection. Port Binding check LAN2. Service List select to OTHER. VLAN Mode select to Used. VLAN ID enter 200. Finally click Create.

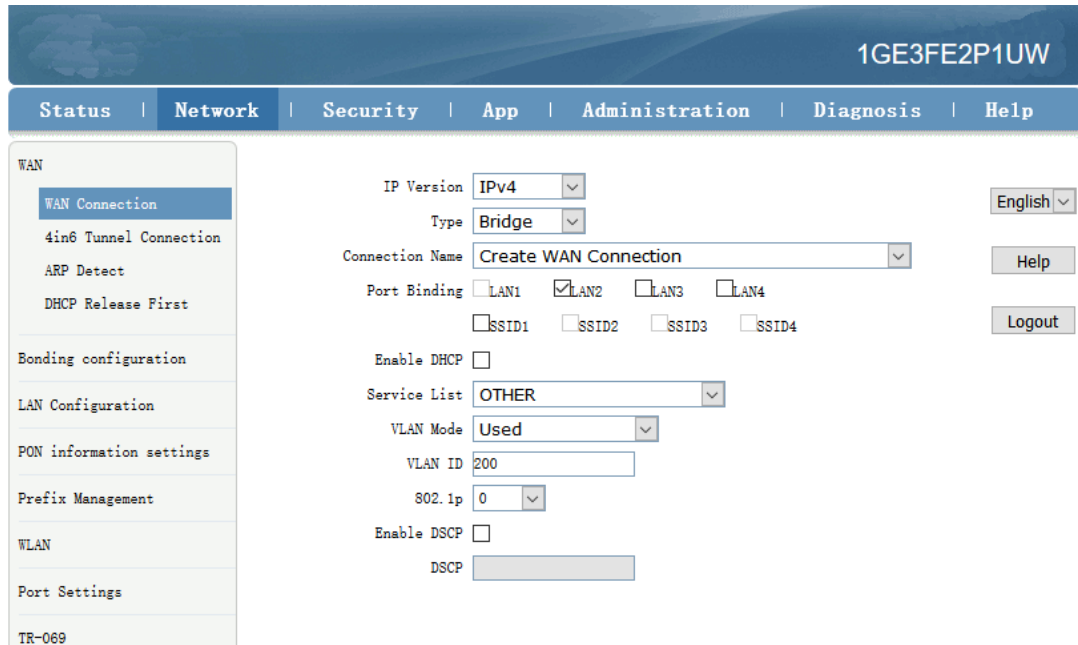

NOTE:

Type select to **Bridge**. Connection Name select to **Create WAN Connection**. Port Binding check **LAN2**. Service List select to **OTHER**. VLAN Mode select to **Used**. VLAN ID enter **200**. Enable DHCP keep default unchecked status.

2. Check ONT Bridge wan status

Click Status→Network Interface→WAN Connection(IPv4).

1GE3FE2P1UW

Status | Network | Security | App | Administration | Diagnosis | Help

Device Information

Network Interface

WAN Connection (IPv4)

WAN Connection (IPv6)

4in6 Tunnel Connection

PON Inform

PON Alarm

User Interface

VoIP Status

Remote Management Status

Type	DHCP
Connection Name	3_INTERNET_R_VID_100
NAT	Enabled
IP	192.168.5.194/255.255.255.0
DNS1	192.168.5.1
DNS2	0.0.0.0
DNS3	0.0.0.0
WAN MAC	E0:67:B3:00:00:BC
Gateway	192.168.5.1
Connection Status	Connected
Remaining Lease Time	85544sec

Type	Bridge Connection
Connection Name	2_Other_B_VID_200

English ▾

Help

Logout

3. Configure multicast vlan on ONT web

Click App→Normal App→IPTV. Modify the Bridge WAN 2_Other_B_VID_200

1GE3FE2P1UW

Status | Network | Security | App | Administration | Diagnosis | Help

Advance NAT Configuration

Voip configuration

IGMP

Normal App

Home storage

IPTV

MLD Configuration

DNS Service

Port Filter

Multicast

Connection Name

Multicast VLAN

Modify

Connection Name	Multicast VLAN	DNS2 server
3_INTERNET_R_VID_100		
2_Other_B_VID_200		

English ▾

Help

Logout

Multicast VLAN enter 200. Then click Modify.

1GE3FE2P1UW

Status | Network | Security | **App** | Administration | Diagnosis | Help

Advance NAT Configuration

Voip configuration

IGMP

Normal App

Home storage

IPTV

MLD Configuration

DNS Service

Port Filter

Multicast

Connection Name

Multicast VLAN

Modify

English ▾

Help

Logout

Connection Name	Multicast VLAN	DNS2 server
3_INTERNET_R_VID_100		
2_Other_B_VID_200	200	

---end

5.7.5 Configure Gateway ONU (HGU) VOIP Service--ZTE Solution ONU

premise condition

- OLT connect to uplink device and open multicast service
- OLT have created vlan for VOIP
- OLT have configured GE port VOIP vlan
- OLT have configured PON port VOIP vlan
- ONU have registered

1. Configure Voice in ONT web

Click Network→WAN→WAN Connection. Type Select to DHCP. Connection Name Select to Create WAN Connection. Service List select to VOICE. VLAN Mode select to Used. VLAN ID enter 300. Finally click Create.

1GE3FE2P1UW

Status | Network | Security | App | Administration | Diagnosis | Help

WAN

WAN Connection

4in6 Tunnel Connection

ARP Detect

DHCP Release First

Bonding configuration

LAN Configuration

PON information settings

Prefix Management

IP Version

Type

Connection Name

Service List

VLAN Mode

VLAN ID

802.1p

MTU

English | Help | Logout

2. Configure ONT VOIP

Click App→Voip configuration→SIP. Enter Sip server ip address.

1GE3FE2P1UW

Status | Network | Security | App | Administration | Diagnosis | Help

Advance NAT Configuration

Voip configuration

SIP

account information

Call control

Additional Setting

Digital Map

VOIP QoS

Agreement cancellation

Media

Advanced

Call Display

SLIC Configuration

IGMP

Normal App

MLD Configuration

DNS Service

Port Filter

Enable

Sip Protocol

Local Port (0 ~ 65535)

Primary Register Server

Primary Proxy Server

Primary Outbound Proxy Server

Primary Proxy Port (0 ~ 65535)

Secondary Register Server

Secondary Proxy Server

Secondary Outbound Proxy Server

Secondary Proxy Port (0 ~ 65535)

Register Expires sec

Unregister On Reboot

Enable Link Test

Link Test Interval sec

Enable # escape

Register Retry Interval sec

English | Help | Logout

3. Configure ONT VOIP Account

Click App→Voip Configuration→account information. Enter Sip account information.

1GE3FE2P1UW

Status | Network | Security | **App** | Administration | Diagnosis | Help

Advance NAT Configuration

Voip configuration

SIP

account information

Call control

Additional Setting

Digital Map

VOIP QoS

Agreement cancellation

Media

Advanced

Call Display

SLIC Configuration

Enable

Sip Account

Password

Authentication user name

Enable	Sip Account	Authentication user name	Modefy
Yes	895	895	
Yes	896	896	

English ▾

Help

Logout

NOTE:

Sip Account, Password, Authentication user name please modify according to the user's actual need.

4. Check Sip account register status

Click Status→VoIP Status→Register Status.

Status | Network | Security | App | Administration | Diagnosis | Help

Device Information

Network Interface

User Interface

VoIP Status

Register Status

Sip Account

Remote ManageMent Status

Line Phone	Line Phone1
Register Status	Registered
Line Phone	Line Phone2
Register Status	Registered

English ▾

Help

Logout

Refresh

NOTE:

The **Register Status** is Registered mean sip account register successfully.

----end

6 Configure OLT QinQ Service

6.1 Data Plan

Main Data Plan List	
Configure Item	Data
VLAN	SVLAN 500 : QinQ service outer vlan CVLAN 100-200 : QinQ service outer vlan
OLT Port Configure	Ge8 : VLAN 500 Hybrid mode PON8 : VLAN 500 Hybrid mode
Bridge ONT Port Configure	LAN 3 : VLAN 100

6.2 Configure Processes

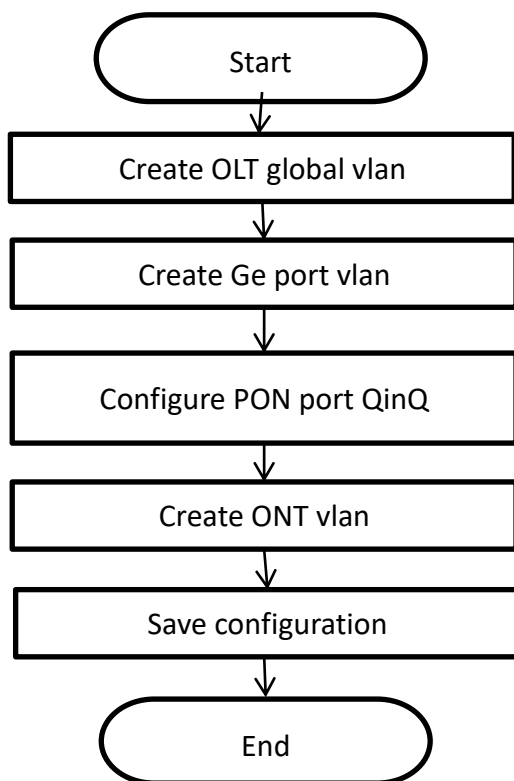

6.3 Configure OLT

Create outer vlan:

Operate **show vlan all** command can query the existing vlan, If the existing vlan does not meet the need, we can use vlan command to create outer vlan.

```
epon# vlan 500
epon(vlan-500)# exit
```

Configure GE port QinQ outer vlan:

```
epon# swport ge8
epon(GE-8)# vlan add 500 tag
epon(GE-8)# exit
```

Configure PON port QinQ outer vlan and PON port QinQ:

```
epon# swport ge16
epon(GE-16)# vlan add 500 tag
epon(GE-16)# exit
epon# olt 8
epon(olt-8)# qinq enable 500 raw-vlan-id-inbound 100-200 ge8
```

7 Common Command Description

command	description
show vlan all	View OLT vlan summary
show system infor	View OLT information of version, MAC, sequence number, model
show igmp group all	View the list of multicast groups that the OLT joins
show running-config all	View the running configuration of the OLT
show startup-config all	View the saved configuration of the OLT
show system ipconfig	View the in-band, out-of-band management IP address information of the OLT
show olt <oltid> onu <onuid> ctc sn	View the version information for the ONU
show olt <oltid> online-onu	View the online ONU on the PON port
show olt <oltid> optical-online-onu	View all the online ONU information of optical power, voltage, current, temperature and so on

8 OLT Service Configuration ---EMS Method

This section mainly introduces 4Port/8Port OLT internet service and multicast service in FTTH environment. The following will introduce the service configuration way for OLT and ONU according to the bridge ONU(SFU).

8.1 Data Plan

Main Data Plan List	
Configuration Item	Data
VLAN Data	VLAN 110: Internet Service VLAN 120: IPTV Service
OLT Port Setting	Ge5: VLAN 110 access mode Ge6: VLAN 120 access mode PON8: VLAN 110, VLAN 120 trunk mode
ONU Register ID	Bridge ONU ID: 1
Bridge ONU Port config	LAN 1: VLAN 110 LAN 2: VLAN 120

8.2 Configuration Guide

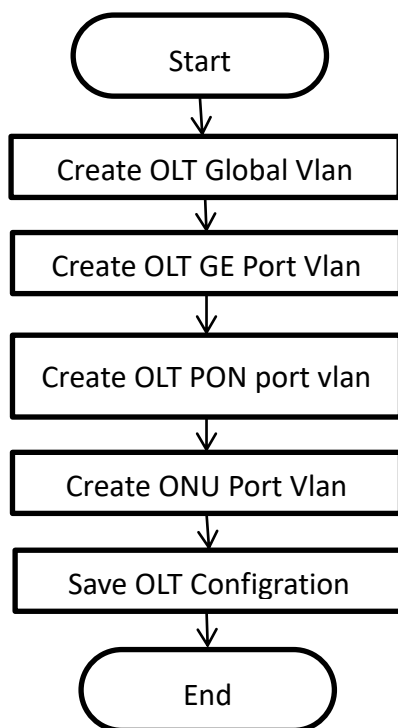

8.3 Configure OLT Service

8.3.1 Configure OLT Global Vlan

Click “Switch Control Card --> VLAN Management” to query the created Vlan.

If the created vlan cannot meet the requirements, vlan can be created by clicking the **Vlan Management**. According to the data planning, we create vlan110 and vlan120 firstly:

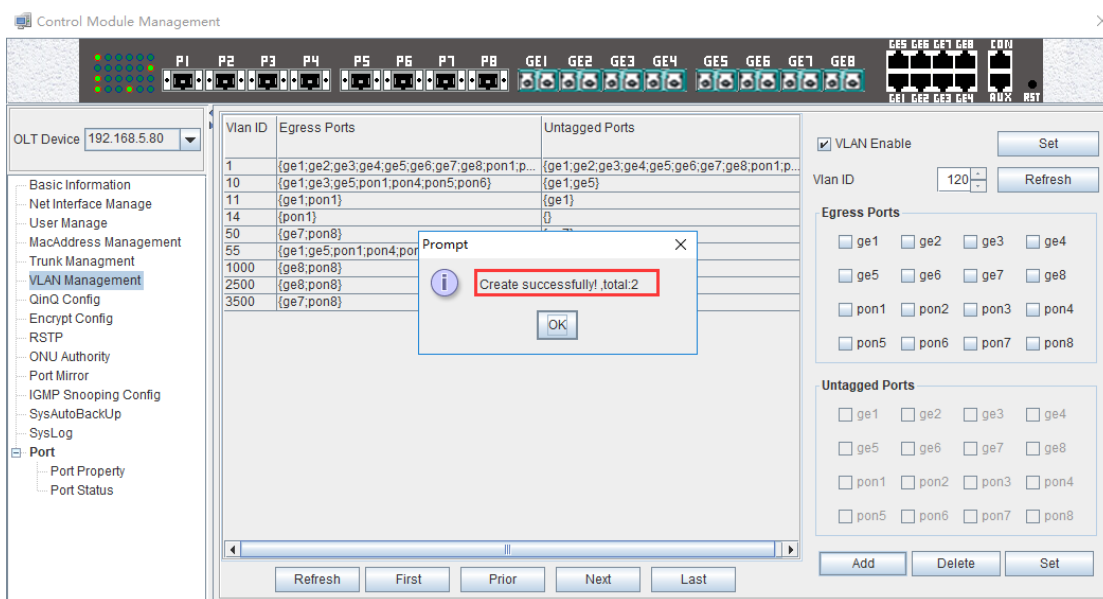
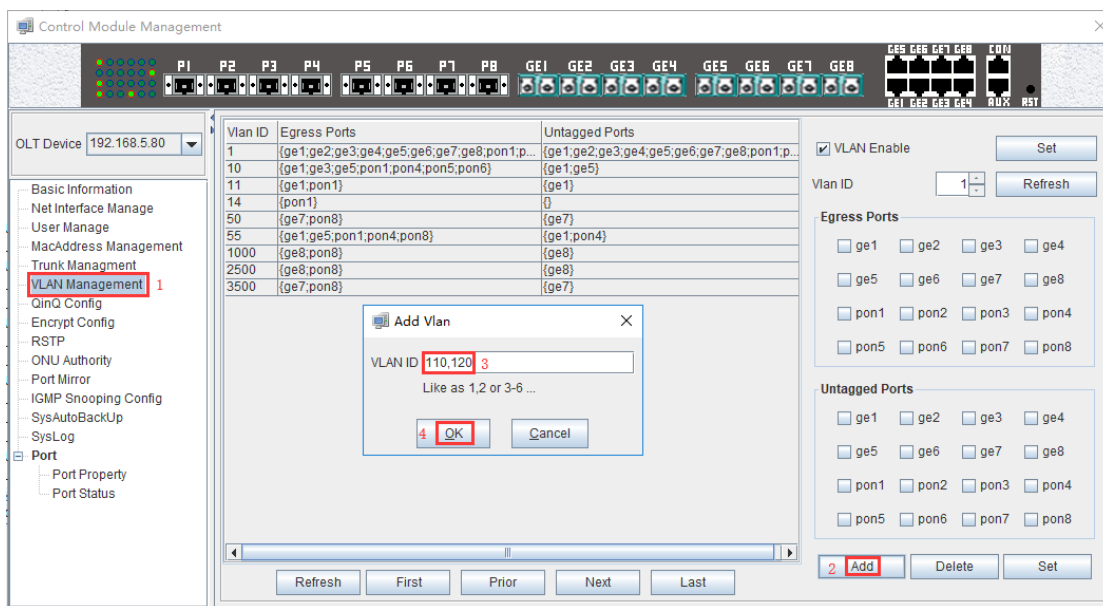
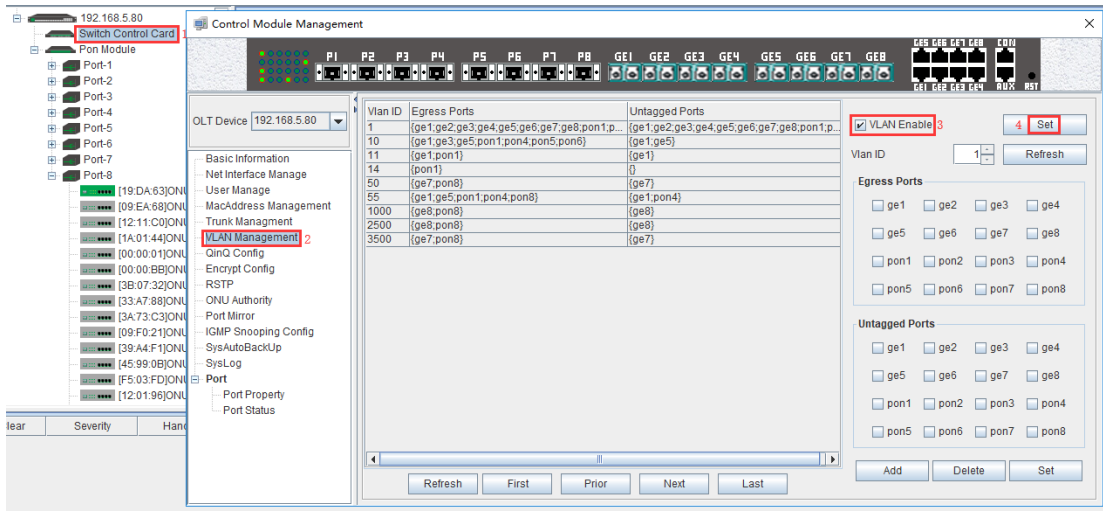

8.3.2 Configure OLT GE Port Service Vlan

1. Click “Switch Control Card --> Port Property”, and then configure GE 5 port pvid is 110:

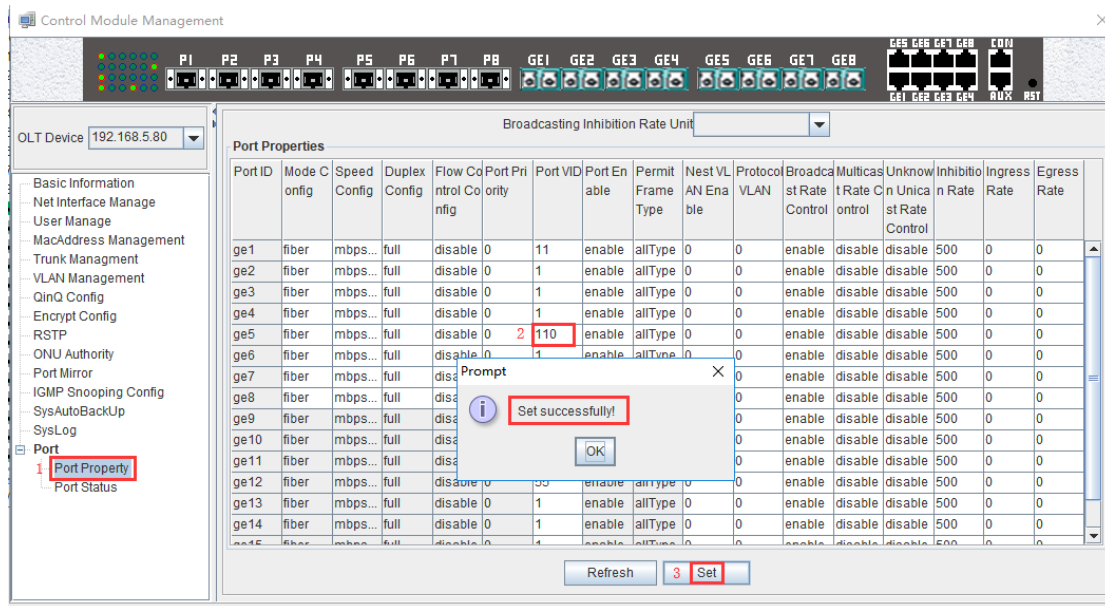

2. Click “Switch Control Card --> Port Property”, and then configure GE 6 port pvid is 120:

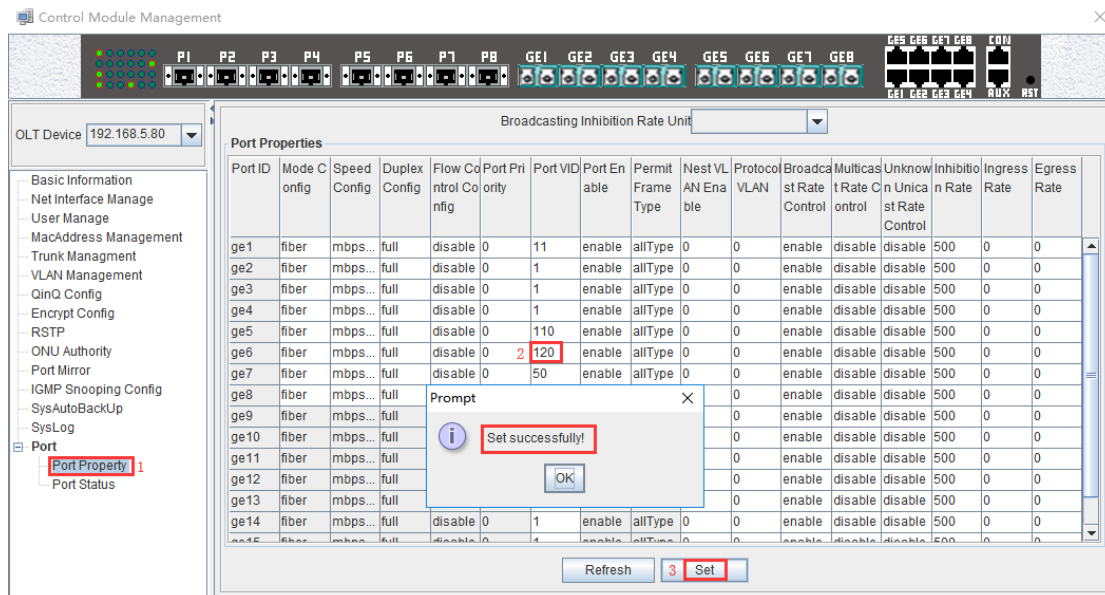

3. Click “Switch Control Card --> VLAN Management”, and then add the vlan 110 to GE 5 port as untag mode ,which is access :

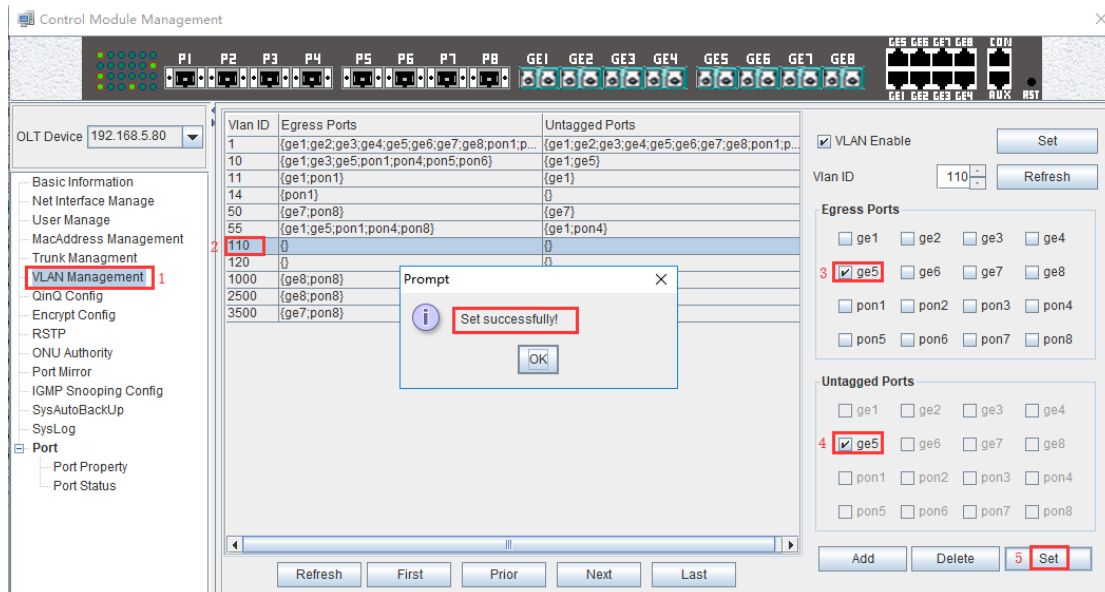

4. Click “Switch Control Card --> VLAN Management”, and then add the vlan 110 to GE 6 port as untag mode ,which is access :

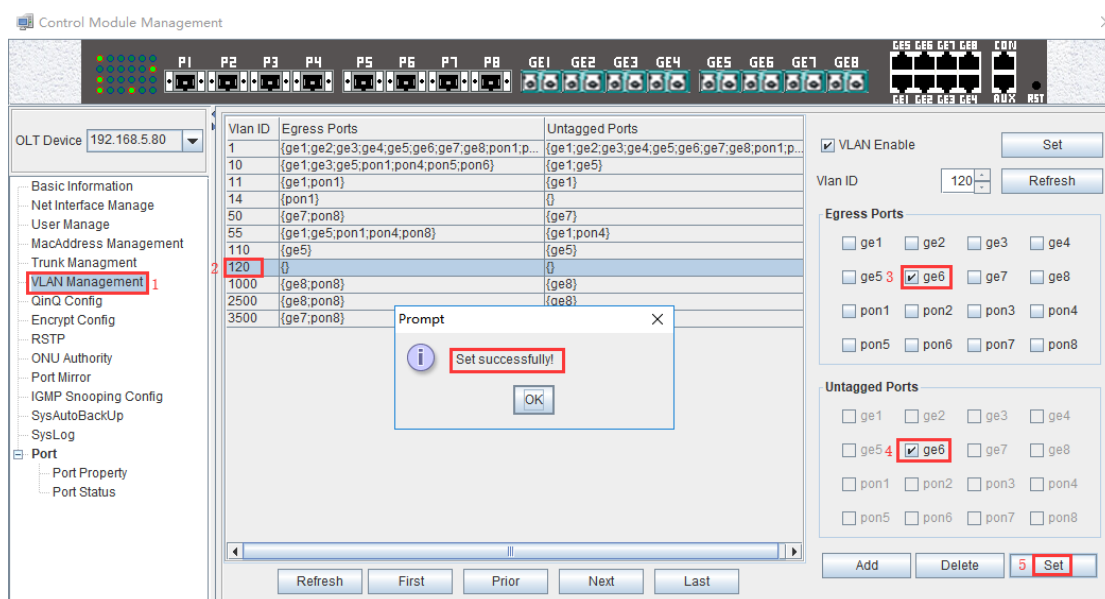

8.3.3 Configure OLT PON Port Service Vlan

1. Click “Switch Control Card --> VLAN Management”, and then add the vlan 110 to PON 8 port as tag mode ,which is trunk :

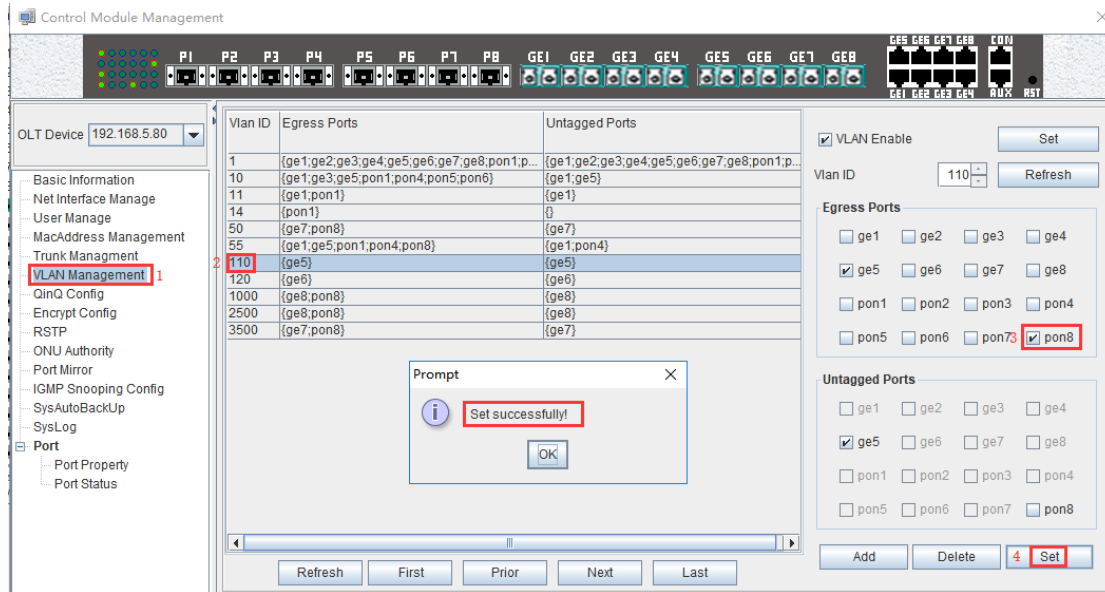

2. Click “Switch Control Card --> VLAN Management”, and then add the vlan 120 to PON 8 port as tag mode ,which is trunk :

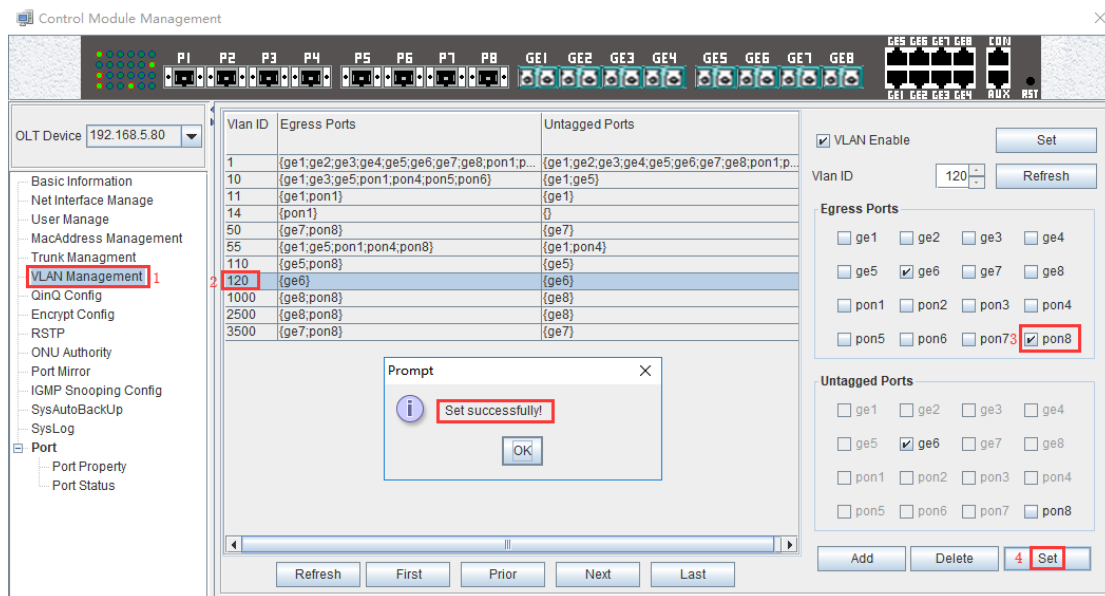

8.4 Configure Bridge ONU(SFU) Service

We need enter OLT to config ONU one by one,config way as follows:

8.4.1 Configure Bridge Onu(SFU) Internet Service

Premise condition of ONU to open internet service:

- OLT connect to uplink device and open internet service
- OLT have created vlan for internet service
- OLT have configured GE port vlan
- OLT have configured PON port vlan

- ONU have registered

SFU ethernet port vlan mode have transparent,tag(access),trunk mode and so on,we can according to our network plan configure different mode.all onu vlan is configured by OLT,configure way as follows:

1. Click “**Pon Module --> Port-8 --> ONU-1 --> ONU VLAN**” , and then configure ONU1 eth1 vlan mode is tag(access):

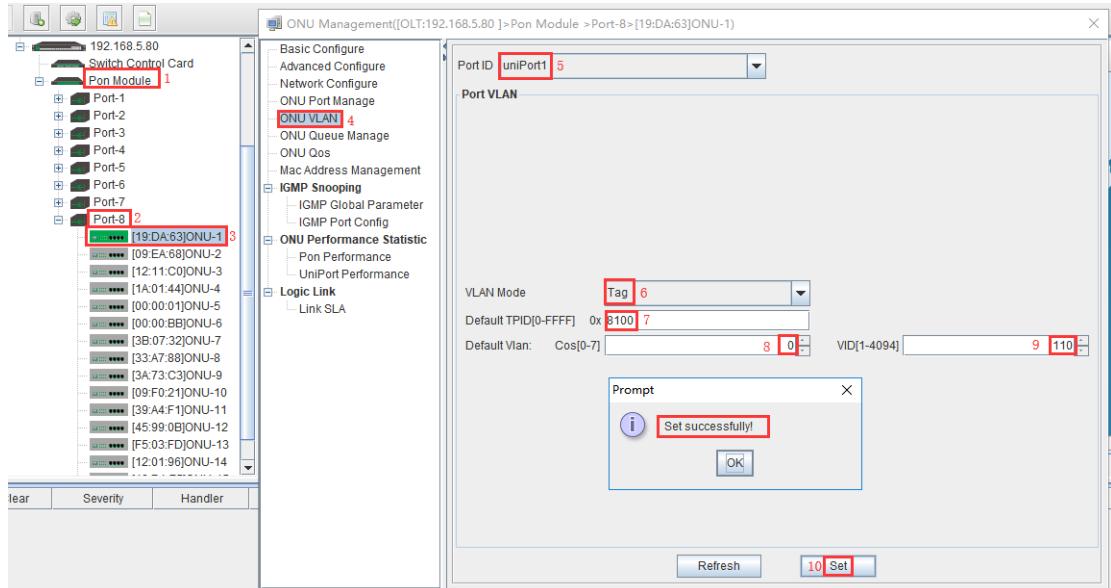

8.4.2 Configure Bridge Onu(SFU) Multicast Service

Premise Condition

- OLT connect to uplink device and open service
- OLT have created vlan for multicast service
- OLT have configured GE port vlan
- OLT have configured PON port vlan
- ONU have registered

We need enter OLT to config ONU multicast service,configure way as follows:

1. Click “**Pon Module --> Port-8 --> ONU-1 --> IGMP Global Parameter**” , and then config ONU1 multicast vlan mode is snooping and enable the fast leave:

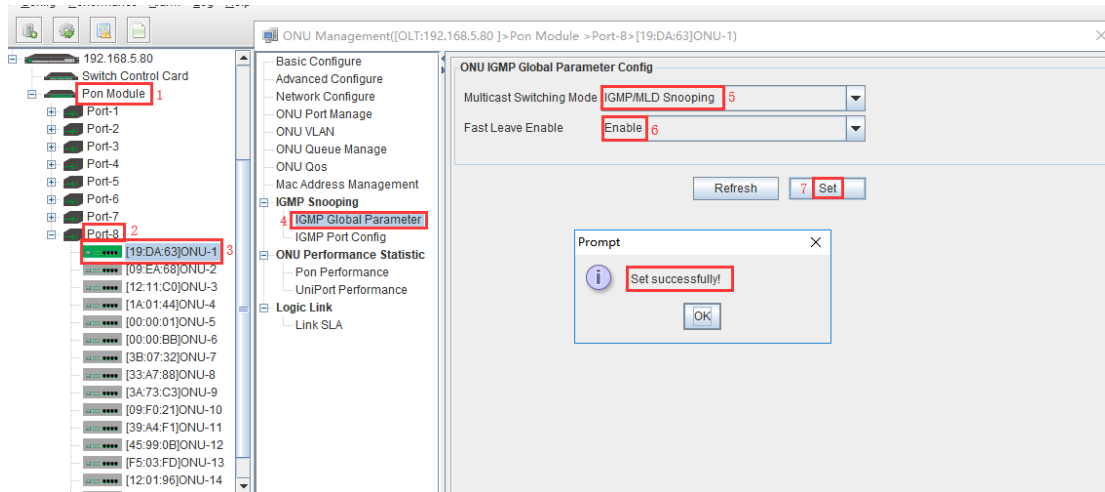

2. Click “**Pon Module --> Port-8 --> ONU-1 --> IGMP Port Config**”, and then config ONU1 eth2 multicast mode is strip vlan tag:

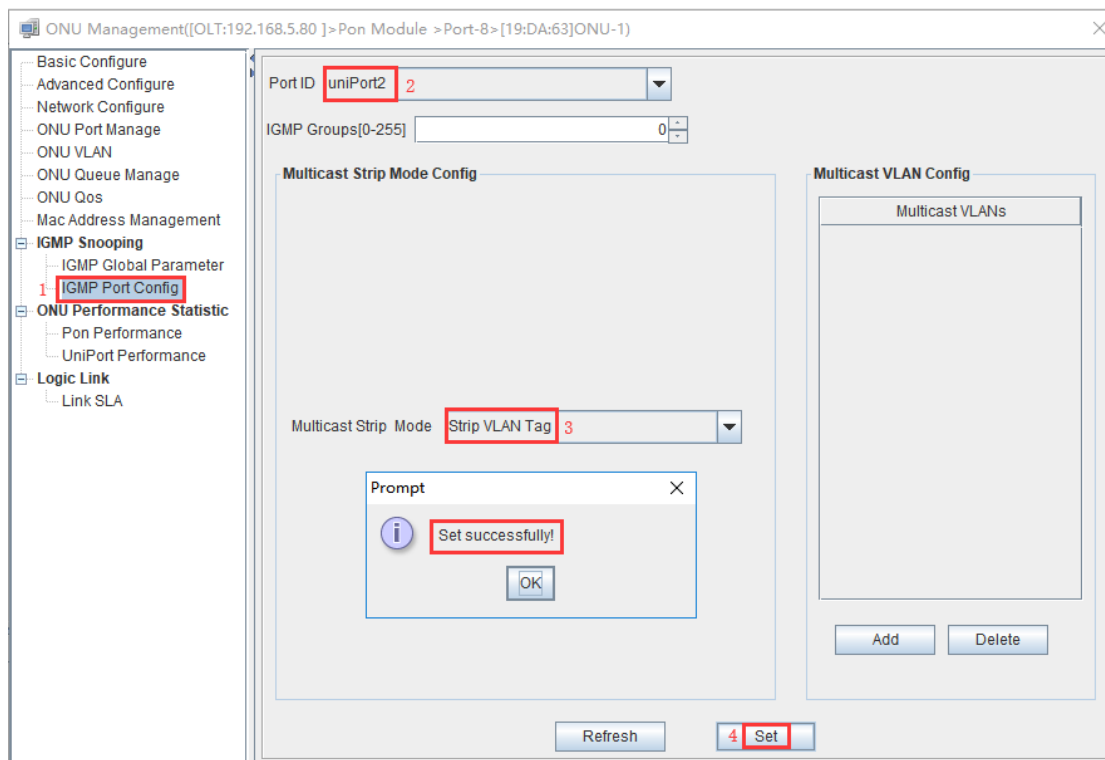

3. Click “**Pon Module --> Port-8 --> ONU-1 --> IGMP Port Config**”, and then config ONU1 eth2 multicast vlan is 120:

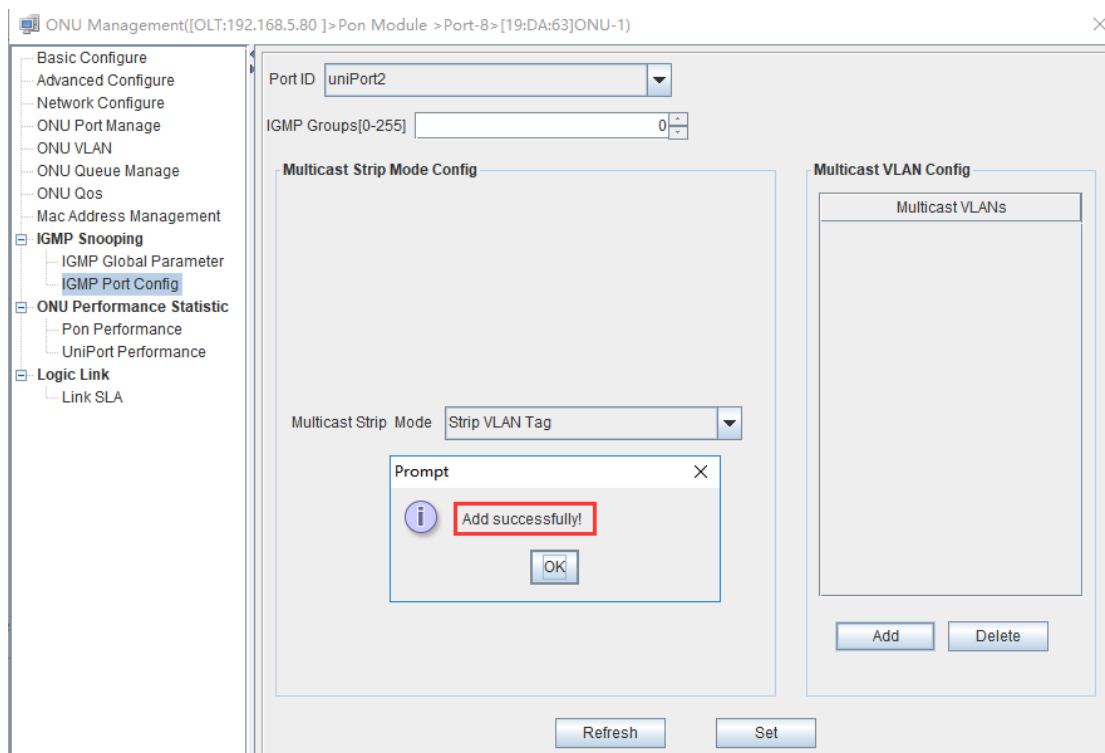
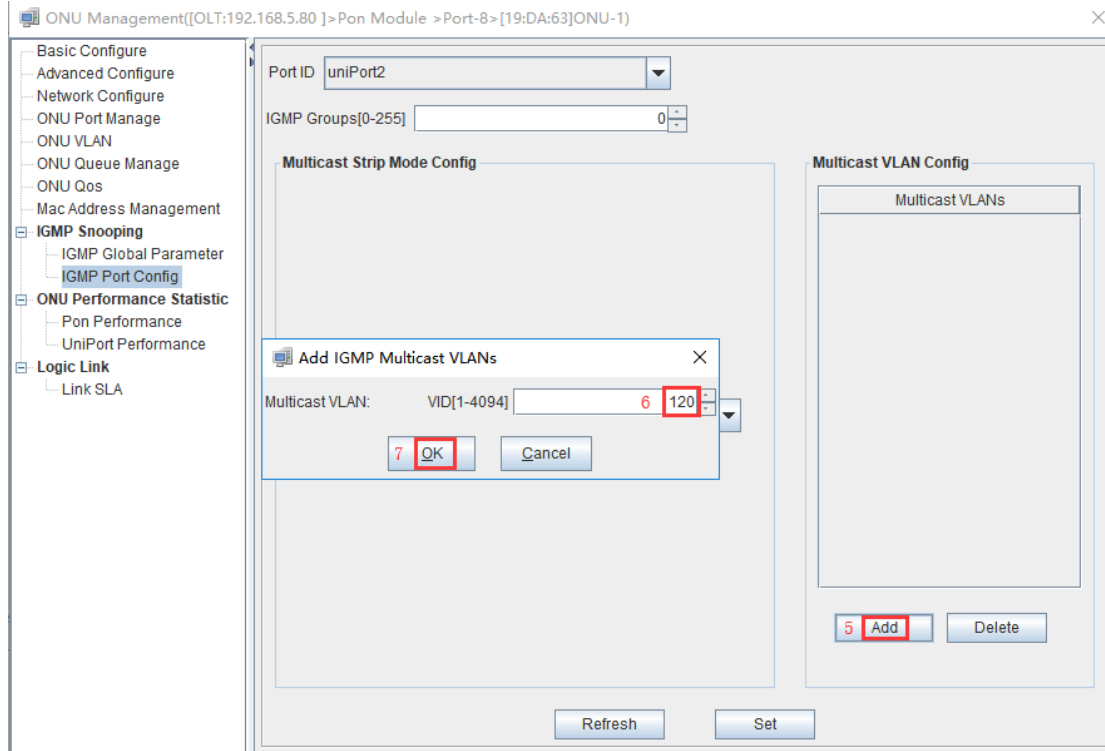

9 Configure Service In OLT ---WEB Method

This section mainly introduces 4Port/8Port OLT internet service and multicast service in FTTH environment. The following will introduce the service configuration way for OLT and ONU

according to the bridge ONU(SFU).

9.1 Data Plan

Main Data Plan List	
Configuration Item	Data
VLAN Data	VLAN 110: Internet Service VLAN 120: IPTV Service
OLT Port Setting	Ge5: VLAN 110 access mode Ge6: VLAN 120 access mode PON8: VLAN 110, VLAN 120 trunk mode
ONU Register ID	Bridge ONU ID: 1
Bridge ONU Port config	LAN 1: VLAN 110 LAN 2: VLAN 120

9.2 Configuration Guide

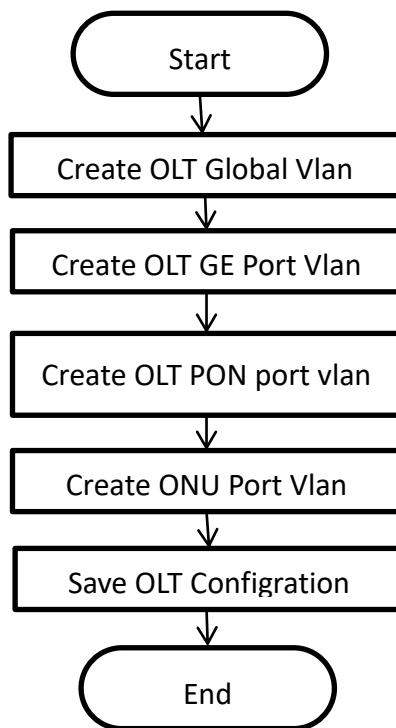

9.3 Configure OLT Service

9.3.1 Configure OLT Global Vlan

Click the “**Switching Board --> Vlan Manage**” to enable the Vlan.

If the created vlan cannot meet the requirements, vlan can be created by clicking the “**VLAN Manage** “. According to the data planning, we create vlan110 and vlan120 firstly:

xPON OLT | Version: V1.2.0 | Login-Mode: Administrator | Language: English | Exit

Topology | PATH:test1>Switching Board>VLAN Manage

Switching Board

- Switch-Config
- Net Interface
- Port Status
- Port Property
- Mac AddressList
- Packet Suppress
- Performance Statistics
- VLAN Manage**
- TRUNK
- RSTP
- Port Mirror
- IGMP Snooping

VLAN Manage

VLANEnable: enable 3

VLANID	Tagged Port	Untagged Port
1		ge1;ge2;ge3;ge4;ge5;ge6;ge7;ge8;pon1;pon2;pon3;pon4;pon5;pon6;pon7;pon8;
10	ge3;pon1;pon4;pon5;pon6;	ge1;ge5;
11	pon1;	ge1;
14	pon1;	
50	pon8;	ge7;
55	ge5;pon1;pon8;	ge1;pon4;
1000	pon8;	ge8;
2500	pon8;	ge8;
3500	pon8;	ge7;

refresh add 4 set First Next

xPON OLT | Version: V1.2.0 | Login-Mode: Administrator | Language: English | Exit

Topology | PATH:test1>Switching Board>VLAN Manage

Switching Board

- Switch-Config
- Net Interface
- Port Status
- Port Property
- Mac AddressList
- Packet Suppress
- Performance Statistics
- VLAN Manage**
- TRUNK
- RSTP
- Port Mirror
- IGMP Snooping

VLAN Manage

VLANEnable: enable

VLANID	Tagged Port	Untagged Port
1		ge1;ge2;ge3;ge4;ge5;ge6;ge7;ge8;pon1;pon2;pon3;pon4;pon5;pon6;pon7;pon8;
10	ge3;pon1;pon4;pon5;pon6;	ge1;ge5;
11	pon1;	ge1;
14	pon1;	
50	pon8;	ge7;
55	ge5;pon1;pon8;	ge1;pon4;
1000	pon8;	ge8;
2500	pon8;	ge8;
3500	pon8;	ge7;

refresh 3 add set First Next

xPON OLT | Version: V1.2.0 | Login-Mode: Administrator | Language: English | Exit

Topology | PATH:test1>Switching Board>VLAN Manage

Switching Board

- Switch-Config
- Net Interface
- Port Status
- Port Property
- Mac AddressList
- Packet Suppress
- Performance Statistics
- VLAN Manage**
- TRUNK
- RSTP
- Port Mirror
- IGMP Snooping

VLAN Manage

vlanIndex: 110 4

Egress port				untagged port			
<input type="checkbox"/> GE1	<input type="checkbox"/> GE2	<input type="checkbox"/> GE3	<input type="checkbox"/> GE4	<input type="checkbox"/> GE1	<input type="checkbox"/> GE2	<input type="checkbox"/> GE3	<input type="checkbox"/> GE4
<input type="checkbox"/> GE5	<input type="checkbox"/> GE6	<input type="checkbox"/> GE7	<input type="checkbox"/> GE8	<input type="checkbox"/> GE5	<input type="checkbox"/> GE6	<input type="checkbox"/> GE7	<input type="checkbox"/> GE8
<input type="checkbox"/> PON1	<input type="checkbox"/> PON2	<input type="checkbox"/> PON3	<input type="checkbox"/> PON4	<input type="checkbox"/> PON1	<input type="checkbox"/> PON2	<input type="checkbox"/> PON3	<input type="checkbox"/> PON4
<input type="checkbox"/> PON5	<input type="checkbox"/> PON6	<input type="checkbox"/> PON7	<input type="checkbox"/> PON8	<input type="checkbox"/> PON5	<input type="checkbox"/> PON6	<input type="checkbox"/> PON7	<input type="checkbox"/> PON8

5 set refresh return

xPON OLT | Version: V1.2.0 | Login-Mode: Administrator | Language: English | Exit

Topology | PATH:test1>Switching Board>VLAN Manage

Switching Board

- Switch-Config
- Net Interface
- Port Status
- Port Property
- Mac AddressList
- Packet Suppress
- Performance Statistics
- VLAN Manage**
- TRUNK
- RSTP
- Port Mirror
- IGMP Snooping

VLAN Manage

VLANEnable: enable

VALNID	Tagged Port	Untagged Port	vlan-edit	vlan-clear
10	ge3:pon1:pon4:pon5:pon6;	ge1:ge5;	edit	delete
50	pon8;	ge7;	edit	delete
55	ge5:pon1:pon8;	ge1:pon4;	edit	delete
110			edit	delete
1000	pon8;	ge8;	edit	delete
2500	pon8;	ge8;	edit	delete
3500	pon8;	ge7;	edit	delete

refresh 1 add set First Next

xPON OLT | Version: V1.2.0 | Login-Mode: Administrator | Language: English | Exit

Topology | PATH:test1>Switching Board>VLAN Manage

Switching Board

- Switch-Config
- Net Interface
- Port Status
- Port Property
- Mac AddressList
- Packet Suppress
- Performance Statistics
- VLAN Manage**
- TRUNK
- RSTP
- Port Mirror
- IGMP Snooping

VLAN Manage

vlanIndex: 120 2

Egress port				untagged port			
<input type="checkbox"/> GE1	<input type="checkbox"/> GE2	<input type="checkbox"/> GE3	<input type="checkbox"/> GE4	<input type="checkbox"/> GE1	<input type="checkbox"/> GE2	<input type="checkbox"/> GE3	<input type="checkbox"/> GE4
<input type="checkbox"/> GE5	<input type="checkbox"/> GE6	<input type="checkbox"/> GE7	<input type="checkbox"/> GE8	<input type="checkbox"/> GE5	<input type="checkbox"/> GE6	<input type="checkbox"/> GE7	<input type="checkbox"/> GE8
<input type="checkbox"/> PON1	<input type="checkbox"/> PON2	<input type="checkbox"/> PON3	<input type="checkbox"/> PON4	<input type="checkbox"/> PON1	<input type="checkbox"/> PON2	<input type="checkbox"/> PON3	<input type="checkbox"/> PON4
<input type="checkbox"/> PON5	<input type="checkbox"/> PON6	<input type="checkbox"/> PON7	<input type="checkbox"/> PON8	<input type="checkbox"/> PON5	<input type="checkbox"/> PON6	<input type="checkbox"/> PON7	<input type="checkbox"/> PON8

3 set refresh return

9.3.2 Configure OLT GE Port Service Vlan

1. Click “Switching Board --> Port Property”, and then config GE 5 port pvid is 110 :

xPON OLT | Version: V1.2.0 | Login-Mode: Administrator | Language: English | Exit

Topology | PATH:test1>Switching Board>Port Property

Switching Board

- Switch-Config
- Net Interface
- Port Status
- Port Property**
- Mac AddressList
- Packet Suppress
- Performance Statistics
- VLAN Manage
- TRUNK
- RSTP
- Port Mirror
- IGMP Snooping

Port Property

portId	speed(mbps)	dup	flowCtl	pri	PVID	portEnable	perFramType	ingressRate	egressRate	Operation
1	1000	full	disable	0	11	enable	allType	0	0	edit
2	1000	full	disable	0	1	enable	allType	0	0	edit
3	1000	full	disable	0	1	enable	allType	0	0	edit
4	1000	full	disable	0	1	enable	allType	0	0	edit
5	1000	full	disable	0	1	enable	allType	0	0	3 edit
6	1000	full	disable	0	1	enable	allType	0	0	edit
7	100	full	disable	0	50	enable	allType	0	0	edit
8	1000	full	disable	0	2500	enable	allType	0	0	edit

refresh

xPON OLT | Version: V1.2.0 | Login-Mode: Administrator | Language: English | Exit

Topology | PATH:test1>Switching Board>Port Property

test1
Main Board
Switching Board
PON Board
PON1
PON2
PON3
PON4
PON5
PON6
PON7
PON8
ONU-1
ONU-2
ONU-3
ONU-4
ONU-5
ONU-6
ONU-7
ONU-8
ONU-9
ONU-10
ONU-11
ONU-12
ONU-13
ONU-14
ONU-15

Switching Board
Switch-Config
Net Interface
Port Status
Port Property
Mac AddressList
Packet Suppress
Performance Statistics
VLAN Manage
TRUNK
RSTP
Port Mirror
IGMP Snooping

Port Property

Port Enable: enable
Speed: mbps1G
Duplex: full
Flow Control: disable
Port Priority: 0
Port VID: 110
Permit Frame Type: allType
Ingress Rate: 0 (kps)
Egress Rate: 0 (kps)

5 set refresh return

2. Click “Switching Board --> VLAN Manage”,and then add vlan 110 to GE 5 port untag :

xPON OLT | Version: V1.2.0 | Login-Mode: Administrator | Language: English | Exit

Topology | PATH:test1>Switching Board>VLAN Manage

test1
Main Board
Switching Board
PON Board
PON1
PON2
PON3
PON4
PON5
PON6
PON7
PON8
ONU-1
ONU-2
ONU-3
ONU-4
ONU-5
ONU-6
ONU-7
ONU-8
ONU-9
ONU-10
ONU-11
ONU-12
ONU-13
ONU-14
ONU-15

Switching Board
Switch-Config
Net Interface
Port Status
Port Property
Mac AddressList
Packet Suppress
Performance Statistics
VLAN Manage
TRUNK
RSTP
Port Mirror
IGMP Snooping

VLAN Manage

VLANEnable: enable

VALNID	Tagged Port	Untagged Port	vlan-edit	vlan-clear
10	ge3;pon1;pon4;pon5;pon6;	ge1;ge5;	edit	delete
50	pon8;	ge7;	edit	delete
55	ge5;pon1;pon8;	ge1;pon4;	edit	delete
110			edit	delete
120			edit	delete
1000	pon8;	ge8;	edit	delete
2500	pon8;	ge8;	edit	delete
3500	pon8;	ge7;	edit	delete

refresh add set First Next

xPON OLT | Version: V1.2.0 | Login-Mode: Administrator | Language: English | Exit

Topology | PATH:test1>Switching Board>VLAN Manage

test1
Main Board
Switching Board
PON Board
PON1
PON2
PON3
PON4
PON5
PON6
PON7
PON8
ONU-1
ONU-2
ONU-3
ONU-4
ONU-5
ONU-6
ONU-7
ONU-8
ONU-9
ONU-10
ONU-11
ONU-12
ONU-13
ONU-14
ONU-15

Switching Board
Switch-Config
Net Interface
Port Status
Port Property
Mac AddressList
Packet Suppress
Performance Statistics
VLAN Manage
TRUNK
RSTP
Port Mirror
IGMP Snooping

VLAN Manage

Vlan ID:110

Egress port				untagged port			
<input type="checkbox"/> GE1	<input type="checkbox"/> GE2	<input type="checkbox"/> GE3	<input type="checkbox"/> GE4	<input type="checkbox"/> GE1	<input type="checkbox"/> GE2	<input type="checkbox"/> GE3	<input type="checkbox"/> GE4
<input checked="" type="checkbox"/> GE5	<input type="checkbox"/> GE6	<input type="checkbox"/> GE7	<input type="checkbox"/> GE8	<input checked="" type="checkbox"/> GE5	<input type="checkbox"/> GE6	<input type="checkbox"/> GE7	<input type="checkbox"/> GE8
<input type="checkbox"/> PON1	<input type="checkbox"/> PON2	<input type="checkbox"/> PON3	<input type="checkbox"/> PON4	<input type="checkbox"/> PON1	<input type="checkbox"/> PON2	<input type="checkbox"/> PON3	<input type="checkbox"/> PON4
<input type="checkbox"/> PON5	<input type="checkbox"/> PON6	<input type="checkbox"/> PON7	<input type="checkbox"/> PON8	<input type="checkbox"/> PON5	<input type="checkbox"/> PON6	<input type="checkbox"/> PON7	<input type="checkbox"/> PON8

6 Set refresh Return

3. Click “Switching Board --> Port Property”,and then config GE 6 port pvid is 120 :

xPON OLT | Version: V1.2.0 | Login-Mode: Administrator | Language: English | Exit

Topology | PATH:test1>Switching Board>Port Property

Switching Board

- Switch-Config
- Net Interface
- Port Status
- Port Property**
- Mac AddressList
- Packet Suppress
- Performance Statistics
- VLAN Manage
- TRUNK
- RSTP
- Port Mirror
- IGMP Snooping

Port Property

portId	speed(mbps)	dup	flowCtl	pri	PVID	portEnable	perFramType	ingressRate	egressRate	Operation
1	1000	full	disable	0	11	enable	allType	0	0	edit
2	1000	full	disable	0	1	enable	allType	0	0	edit
3	1000	full	disable	0	1	enable	allType	0	0	edit
4	1000	full	disable	0	1	enable	allType	0	0	edit
5	1000	full	disable	0	110	enable	allType	0	0	edit
6	1000	full	disable	0	1	enable	allType	0	0	edit
7	100	full	disable	0	50	enable	allType	0	0	edit
8	1000	full	disable	0	2500	enable	allType	0	0	edit

[refresh](#)

xPON OLT | Version: V1.2.0 | Login-Mode: Administrator | Language: English | Exit

Topology | PATH:test1>Switching Board>Port Property

Switching Board

- Switch-Config
- Net Interface
- Port Status
- Port Property**
- Mac AddressList
- Packet Suppress
- Performance Statistics
- VLAN Manage
- TRUNK
- RSTP
- Port Mirror
- IGMP Snooping

Port Property

Port Enable:

Speed:

Duplex:

Flow Control:

Port Priority:

Port VID:

Permit Frame Type:

Ingress Rate: (kps)

Egress Rate: (kps)

4. Click “Switching Board --> VLAN Manage”,and then add vlan 120 to GE 6 port untag :

xPON OLT | Version: V1.2.0 | Login-Mode: Administrator | Language: English | Exit

Topology | PATH:test1>Switching Board>VLAN Manage

Switching Board

- Switch-Config
- Net Interface
- Port Status
- Port Property
- Mac AddressList
- Packet Suppress
- Performance Statistics
- VLAN Manage**
- TRUNK
- RSTP
- Port Mirror
- IGMP Snooping

VLAN Manage

VLANEnable:

VALNID	Tagged Port	Untagged Port	vlan-edit	vlan-clear
10	ge3;pon1;pon4;pon5;pon6;	ge1;ge5;	edit	delete
50	pon8;	ge7;	edit	delete
55	ge5;pon1;pon8;	ge1;pon4;	edit	delete
110		ge5;	edit	delete
120			edit	delete
1000	pon8;	ge8;	edit	delete
2500	pon8;	ge8;	edit	delete
3500	pon8;	ge7;	edit	delete

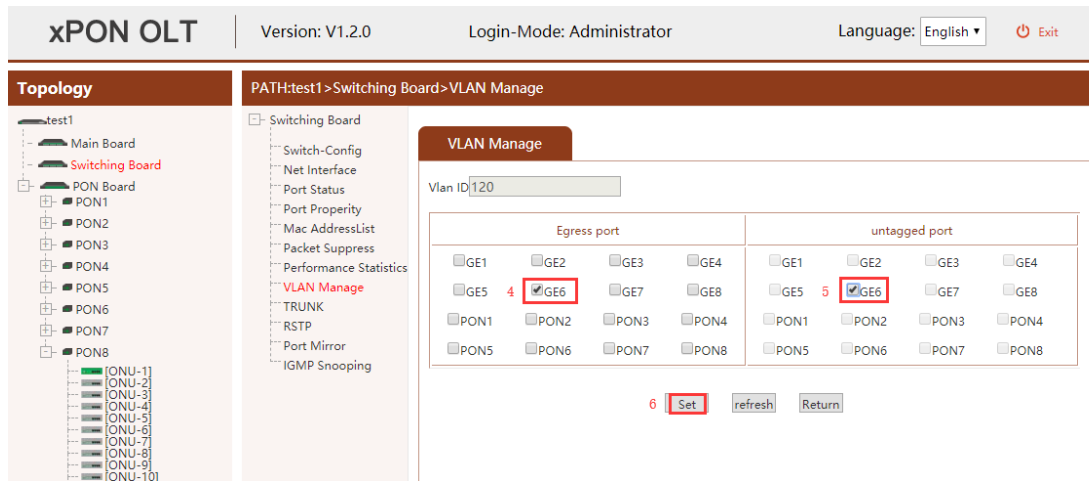

9.3.3 Configure OLT PON Port Service Vlan

1. Click “Switching Board --> VLAN Manage”, and then add vlan 110 to PON port 8 tag :

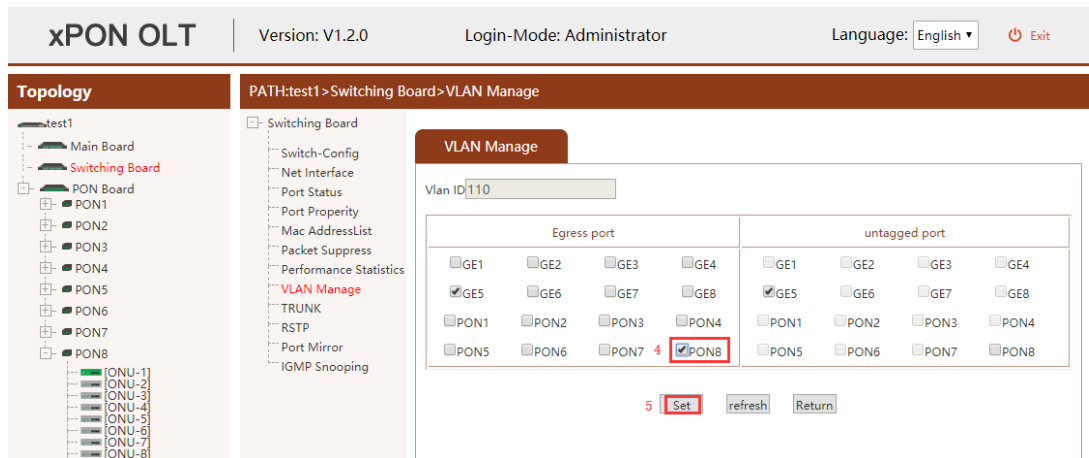
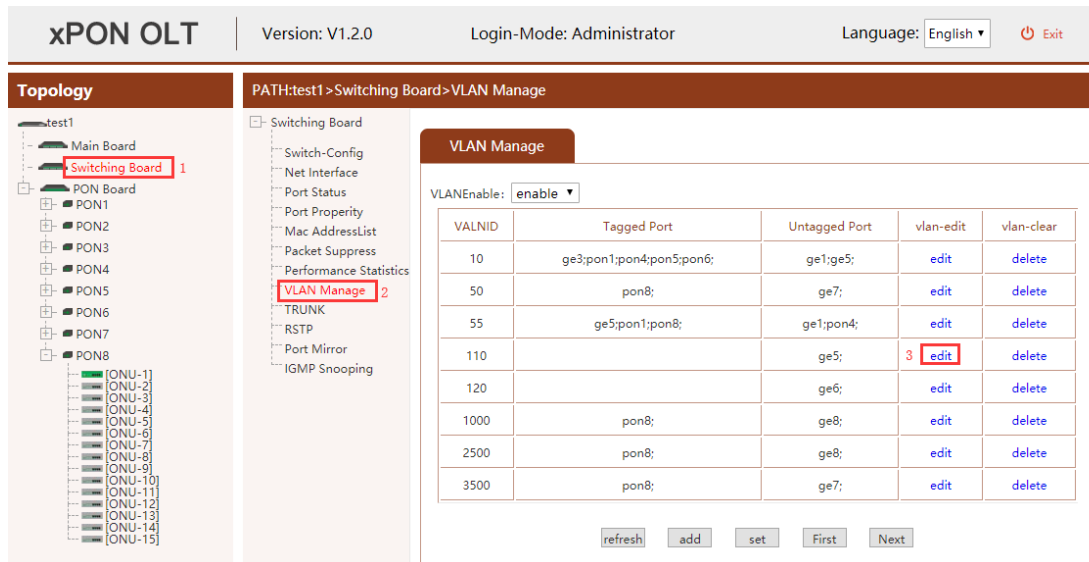

2. Click “Switching Board --> VLAN Manage”, and then add vlan 120 to PON port 8 tag :

xPON OLT | Version: V1.2.0 | Login-Mode: Administrator | Language: English | Exit

Topology | PATH:test1>Switching Board>VLAN Manage

Switching Board

- Switch-Config
- Net Interface
- Port Status
- Port Property
- Mac AddressList
- Packet Suppress
- Performance Statistics
- VLAN Manage**
- TRUNK
- RSTP
- Port Mirror
- IGMP Snooping

VLAN Manage

VLANEnable: enable

VALNID	Tagged Port	Untagged Port	vlan-edit	vlan-clear
10	ge3;pon1;pon4;pon5;pon6;	ge1;ge5;	edit	delete
50	pon8;	ge7;	edit	delete
55	ge5;pon1;pon8;	ge1;pon4;	edit	delete
110	pon8;	ge5;	edit	delete
120		ge6;	edit	delete
1000	pon8;	ge8;	edit	delete
2500	pon8;	ge8;	edit	delete
3500	pon8;	ge7;	edit	delete

refresh add set First Next

xPON OLT | Version: V1.2.0 | Login-Mode: Administrator | Language: English | Exit

Topology | PATH:test1>Switching Board>VLAN Manage

Switching Board

- Switch-Config
- Net Interface
- Port Status
- Port Property
- Mac AddressList
- Packet Suppress
- Performance Statistics
- VLAN Manage**
- TRUNK
- RSTP
- Port Mirror
- IGMP Snooping

VLAN Manage

Vlan ID: 120

Egress port				untagged port			
<input type="checkbox"/> GE1	<input type="checkbox"/> GE2	<input type="checkbox"/> GE3	<input type="checkbox"/> GE4	<input type="checkbox"/> GE1	<input type="checkbox"/> GE2	<input type="checkbox"/> GE3	<input type="checkbox"/> GE4
<input type="checkbox"/> GE5	<input checked="" type="checkbox"/> GE6	<input type="checkbox"/> GE7	<input type="checkbox"/> GE8	<input type="checkbox"/> GE5	<input checked="" type="checkbox"/> GE6	<input type="checkbox"/> GE7	<input type="checkbox"/> GE8
<input type="checkbox"/> PON1	<input type="checkbox"/> PON2	<input type="checkbox"/> PON3	<input type="checkbox"/> PON4	<input type="checkbox"/> PON1	<input type="checkbox"/> PON2	<input type="checkbox"/> PON3	<input type="checkbox"/> PON4
<input type="checkbox"/> PON5	<input type="checkbox"/> PON6	<input type="checkbox"/> PON7	<input checked="" type="checkbox"/> PON8	<input type="checkbox"/> PON5	<input type="checkbox"/> PON6	<input type="checkbox"/> PON7	<input type="checkbox"/> PON8

5 Set refresh Return

9.4 Configure Bridge ONU(SFU) Service

We need enter OLT to config ONU one by one,config way as follows:

9.4.1 Configure Bridge Onu(SFU) Internet Service

Premise condition of ONU to open internet service:

- OLT connect to uplink device and open internet service
- OLT have created vlan for internet service
- OLT have configured GE port vlan
- OLT have configured PON port vlan
- ONU have registered

SFU ethernet port vlan mode have transparent,tag(access),trunk mode and so on,we can according to our network plan configure different mode.all onu vlan is configured by OLT,configure way as follows:

1. Click “**PON Board --> PON8 --> ONU-1 --> VLAN Manage**”, Config ONU1 eth1 vlan

mode is tag(access):

xPON OLT | Version: V1.2.0 | Login-Mode: Administrator | Language: English | Exit

PATH:test1 > PON Board > PON8 > ONU1 > VLAN Manage

Topology

- test1
 - Main Board
 - Switching Board
 - PON Board 1
 - PON1
 - PON2
 - PON3
 - PON4
 - PON5
 - PON6
 - PON7
 - PON8 2
 - ONU-1 3
 - ONU-2
 - ONU-3
 - ONU-4
 - ONU-5
 - ONU-6
 - ONU-7
 - ONU-8
 - ONU-9
 - ONU-10

VLAN Manage

Port ID: Port 1 5

Vlan Mode: Tag Mode

Default TPID[0-FFFF]: 0x 8100

Default Vlan: Cos[0-7]: 0 VID [1-4094]: 50

Port ID	Port Vlan Mode	Operation
1		6 edit

refresh

xPON OLT | Version: V1.2.0 | Login-Mode: Administrator | Language: English | Exit

PATH:test1 > PON Board > PON8 > ONU1 > VLAN Manage

Topology

- test1
 - Main Board
 - Switching Board
 - PON Board
 - PON1
 - PON2
 - PON3
 - PON4
 - PON5
 - PON6
 - PON7
 - PON8
 - ONU-1
 - ONU-2
 - ONU-3
 - ONU-4
 - ONU-5
 - ONU-6
 - ONU-7
 - ONU-8

VLAN Manage

Port ID: 1

Vlan Mode: Tag 7

Default TPID[0-FFFF]: 0x 8100 8

Default Vlan: Cos[0-7]: 0 9 VID [1-4094]: 110 10

11 Set Refresh Return

9.4.2 Configure Bridge Onu(SFU) Multicast Service

Premise Condition

- OLT connect to uplink device and open service
- OLT have created vlan for multicast service
- OLT have configured GE port vlan
- OLT have configured PON port vlan
- ONU have registered

We need enter OLT to config ONU multicast service,configure way as follows:

1. Click “**PON Board--> PON8 --> ONU-1 --> IGMP Global**”, Configure ONU1 multicast vlan mode is snooping and enable the fast leave:

xPON OLT | Version: V1.2.0 | Login-Mode: Administrator | Language: English | Exit

Topology | PATH:test1 > PON Board > PON8 > ONU1 > IGMP Global Parameter

test1
Main Board
Switching Board
PON Board 1
 PON1
 PON2
 PON3
 PON4
 PON5
 PON6
 PON7
 PON8 2
 ONU-1 3
 ONU-2
 ONU-3
 ONU-4
 ONU-5
 ONU-6
 ONU-7
 ONU-8
 ONU-9
 ONU-10
 ONU-11

PON8>ONU1
Baselinfo
Advanced
IP Manage
Port Manage
ONU Qos
Storm Control
Mac AddressList
Performance Statistic
IGMP Global 4
IGMP Port Config
VLAN Manage
Link SLA

IGMP Global Parameter

Multicast Switching Mode: igmp/mld-snooping 5
Fast Leave Enable: enable 6
refresh 7 | set

2. Click “PON Board--> PON8 --> ONU-1 --> IGMP Port Config”, Configure ONU1 eth2 vlan is 120, and multicast vlan mode is untag:

xPON OLT | Version: V1.2.0 | Login-Mode: Administrator | Language: English | Exit

Topology | PATH:test1 > PON Board > PON8 > ONU1 > IGMP Port Config

test1
Main Board
Switching Board
PON Board 1
 PON1
 PON2
 PON3
 PON4
 PON5
 PON6
 PON7
 PON8 2
 ONU-1 3
 ONU-2
 ONU-3
 ONU-4
 ONU-5
 ONU-6
 ONU-7
 ONU-8
 ONU-9
 ONU-10
 ONU-11
 ONU-12
 ONU-13

PON8>ONU1
Baselinfo
Advanced
IP Manage
Port Manage
ONU Qos
Storm Control
Mac AddressList
Performance Statistic
IGMP Global
IGMP Port Config 4
VLAN Manage
Link SLA

IGMP Port Config

Port ID: Port2 5

Port ID	IGMP Groups[0-255]	Multicast Strip Mode	Multicast Vlan	Operation
2	0	Not Strip Vlan Tag		6 Edit

refresh

xPON OLT | Version: V1.2.0 | Login-Mode: Administrator | Language: English | Exit

Topology | PATH:test1 > PON Board > PON8 > ONU1 > IGMP Port Config

test1
Main Board
Switching Board
PON Board
 PON1
 PON2
 PON3
 PON4
 PON5
 PON6
 PON7
 PON8
 ONU-1
 ONU-2
 ONU-3
 ONU-4
 ONU-5
 ONU-6
 ONU-7
 ONU-8
 ONU-9
 ONU-10
 ONU-11
 ONU-12
 ONU-13
 ONU-14
 ONU-15
 ONU-16

PON8>ONU1
Baselinfo
Advanced
IP Manage
Port Manage
ONU Qos
Storm Control
Mac AddressList
Performance Statistic
IGMP Global
IGMP Port Config
VLAN Manage
Link SLA

IGMP Port Config

Port Id:2
IGMP Groups[0-255]: 0
Multicast Strip Mode: Strip Vlan Tag 7
Multicast Vlan Config:
VID[1-4094]:120 8 | Add 9
Multicast VLANs | Operation
set 10 | refresh | return

Concluding Remarks

Thanks for using products of Shenzhen C-Data Technology Co. Ltd.

Contact Information:

Company Address: Room 601, Floor 6, Building F, Songbai Road 1008, Sunshine
Community, Xili Street, Nanshan District, Shenzhen, China

Factory Address: 1st floor, Building B, Wentao Industrial Park, Yingrenshi Community,
Shiyan Avenue, Baoan District, Shenzhen, China

Telephone: 0755-26014509/26014710/26014711

Fax: 0755-26014506

Email: Marketing@cdatatec.com

Website: www.cdatatec.com

www.cdatatec.com.cn